

# BROADCAST NEWS

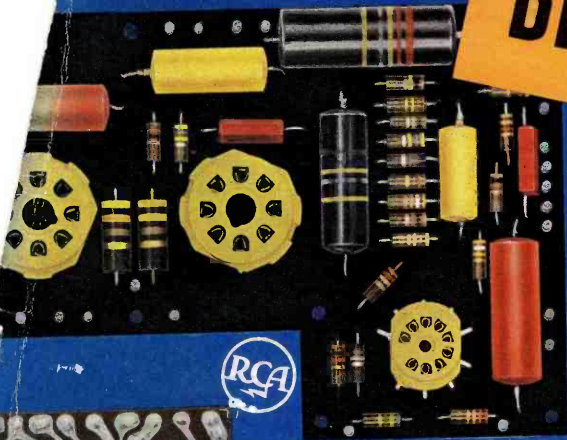

PREAMPLIFIER

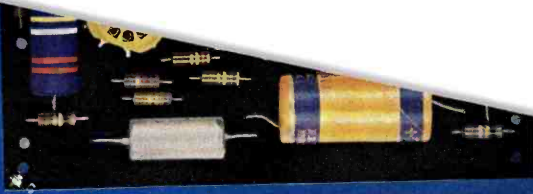

IN THIS ISSUE

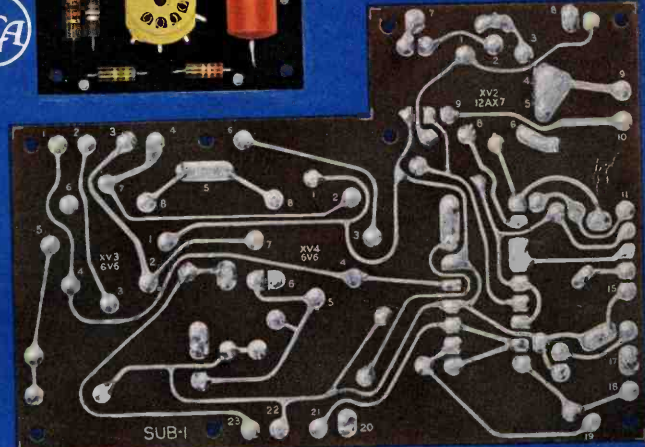

SUB-1

MINIATURE BROADCAST AMPLIFIERS  
USE ETCHED-WIRING TECHNIQUE

Vol. No. 84  
August, 1955

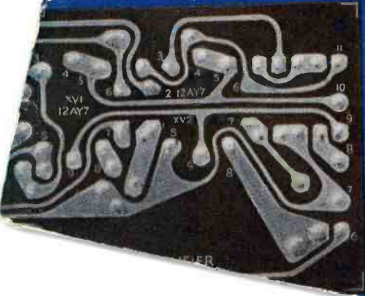

AMPLIFIER

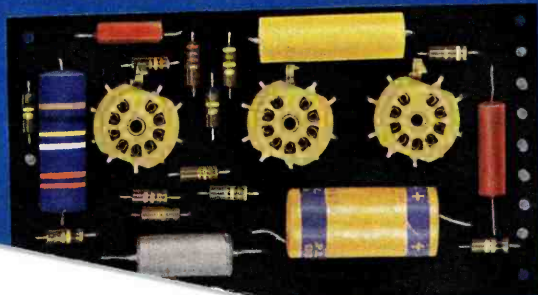



**NOW-11 KW**

**...with RCA's TT-10AL**

**for VHF**

With recent design advances, RCA engineers have increased the power output of the TT-10AL VHF transmitter. This popular transmitter now delivers a full 11 KW of peak visual power (low band)—measured at the output of the sideband filter. If you need this extra KW, it's yours now.

Costs no more than the original 10-KW design—and of course it can handle color.

With power increased to 11 KW, RCA's exclusive TT-10AL—in combination with an RCA 12-section antenna—is the most

outstanding VHF system in the industry, delivering 100 KW ERP at the lowest operating cost of any VHF equipment package now available.

RCA 11 kilowatters are ready to ship. Order yours now for early delivery. For complete details, see your RCA Broadcast Sales Representative. In Canada, write RCA VICTOR Company Ltd., Montreal.

Ask your Broadcast Sales Representative for literature describing RCA's new 11-KW design for channels 2 to 6.

*RCA Pioneered and Developed Compatible Color Television*



**For Color  
or Monochrome**



**RADIO CORPORATION of AMERICA**  
ENGINEERING PRODUCTS DEPARTMENT CAMDEN, N. J.

Vol. No. 84

August, 1955

# BROADCAST NEWS

*published by*

**RADIO CORPORATION OF AMERICA**  
ENGINEERING PRODUCTS DIVISION      CAMDEN, NEW JERSEY

**PRICE**      *In continental U.S.A. --- \$4.00 for 12 issues*  
*In other countries - - - - - \$5.00 for 12 issues*

## CONTENTS

|  |  |           |
|--|--|-----------|
| <b>MINIATURE BROADCAST AMPLIFIERS<br/>USE ETCHED-WIRING TECHNIQUE . . .</b>                      | <i>by G. A. Singer</i>   | <b>8</b>  |
| <b>THREE VIDICON COLOR FILM SYSTEM . . .</b>   | <i>by K. H. Hardiman,<br/>N. L. Hobson, B. F. Melchionni, A. Reisz</i> | <b>14</b> |
| <b>SOME NOTES ON INTEGRATION OF COLOR EQUIPMENT<br/>AND EXISTING MONOCHROME FACILITIES . . .</b> | <i>by A. H. Lind</i>   | <b>30</b> |
| <b>HOW TO GET COLOR EFFECTS FROM<br/>BLACK AND WHITE ARTWORK . . . . .</b>                       |  | <b>34</b> |
| <b>COLOR EFFECTS AND HOW IT WORKS . . .</b>  | <i>by C. R. Monro</i>  | <b>36</b> |
| <b>WHIO's NEW FACILITIES . . . . .</b>   | <i>by Ernest L. Adams</i>  | <b>40</b> |
| <b>THE RCA "AMPLIPHASE" FIFTY . . . . .</b>  | <i>by C. J. Starner,<br/>J. Q. Lawson, C. D. Mulford</i>               | <b>54</b> |
| <b>NEW RCA BROADCAST EQUIPMENT UNVEILED<br/>AT NARTB CONVENTION . . . . .</b>                    |  | <b>60</b> |

**"RCA PIONEERED AND DEVELOPED COMPATIBLE COLOR TELEVISION"**

---

Copyright 1955, Radio Corporation of America, Engineering Products Division, Camden, N. J.

PRINTED  
IN  
U.S.A.

# RCA's 3 Easy Steps

## Step 1

### TRANSMITTING NETWORK COLOR SHOWS

The first step in color for a TV station. Equipment includes: (a) everything you need to transmit network color pictures through your existing system, and (b) color test equipment you need to check signal quality. (All equipment used in Step 1 is used in Steps 2 and 3.)

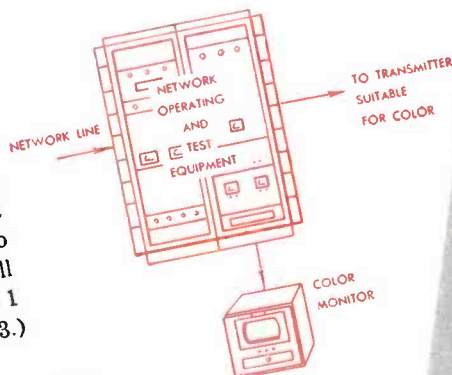

**NEW!**

## Step 2

### ORIGINATING

Everything additionally needed to originate color film shows and color "spots," insert station breaks and provide a color bar test pattern for system checks. Includes: (a) color bar and origination equipment and (b) 3-Vidicon color film and slide equipment.

**NEW!**



To simplify your build-up to full-scale color operation RCA television engineers have developed new color equipments which are available now. Among them are:

#### **NEW 3V Color TV Film Camera**

New 3V Color TV Film Camera requires less than half the auxiliary equipment and cabinet racks needed by other types of color film systems.

#### **NEW Improved Live Camera Chain**

RCA's improved Color Camera Chain, the TK-41, reduces auxiliary camera equipment to 1½ racks.

A new processing amplifier used with both the 3V and Studio Color Cameras combines all signal processing functions in a single chassis.

More than 100 TV stations have already installed RCA color equipment and these are the steps they are using as they swing to color, or expand their present color facilities. Many of these stations are already programming local color on regular schedules.

For help in planning color, start right. Talk to your RCA Broadcast Sales Representative. In Canada, write RCA VICTOR Company Limited, Montreal.

*RCA Pioneered and Developed Compatible Color Television*



# to **COLOR**

...with new  
**RCA color equipments**  
 now in production!

## COLOR FILM SHOWS

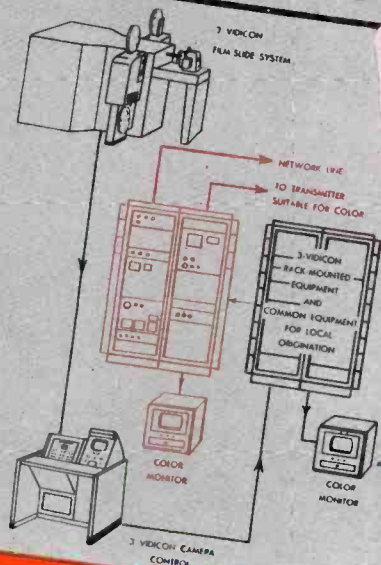

## Step 3

### ORIGINATING LIVE COLOR PROGRAMS

Additional equipment needed for originating live color programs at your station. Includes a complete RCA Studio Color Camera Chain, TK-41. Once this is added to

the equipment in Steps 1 and 2 you can program from four different sources: (1) network, (2) films, (3) slides, (4) your own studio.

**NEW!**

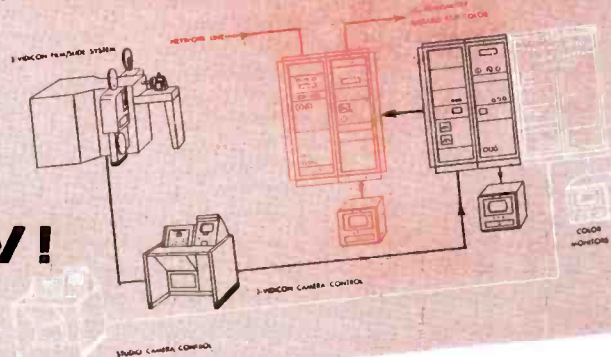

**NEW...** Catalog on Color Equipment for Television contains a complete explanation of these three steps, describes and illustrates all the latest RCA color equipments. The only book of its kind—it's ready now. Ask your RCA Broadcast Sales Representative for a copy.



**RADIO CORPORATION of AMERICA**  
 ENGINEERING PRODUCTS DIVISION  
 CAMDEN, N. J.

# It's Here! RCA's Production

1   
Performs  
4 Functions



## MORE EFFICIENT

"All-in-one" Processing Amplifier combines the signal processing functions of previous channel amplifier, gamma corrector, shading generator, and monitor auxiliary.

Only   
1 1/3 Racks

## COMPACT

The new equipment utilizes only 100 inches of rack space; can be mounted in only 1 1/3 racks for efficient, compact installation.

  
1/3 Less Tubes

## LOW OPERATING COST

Requires half the ac power needs of conventional equipment and permits elimination of 50% of former dc power supplies. Uses 9 less rack-mounted units, and 134 fewer tubes — conservatively operated for extended life.

## FAST SETUP

Centralized controls minimize setup time, require but a single operator for control functions. In addition, over-all stability, improvement in camera performance and picture quality are assured.

No need to wait any longer for *production* live color TV equipment! RCA has it now... a complete new TK-41 Color Camera chain with new all-in-one Processing Amplifier, which combines four major functions in one. It not only provides important savings in components, floor space and operating costs, but assures highest quality at lowest expense.

This is the complete color camera TV equipment that television stations are now using in their swing to color, or in expanding their color facilities. For complete technical information, call your RCA Broadcast Sales representative. In Canada, write RCA VICTOR Company Limited, Montreal.

## RCA TK-41 TYPE COLOR CAMERA

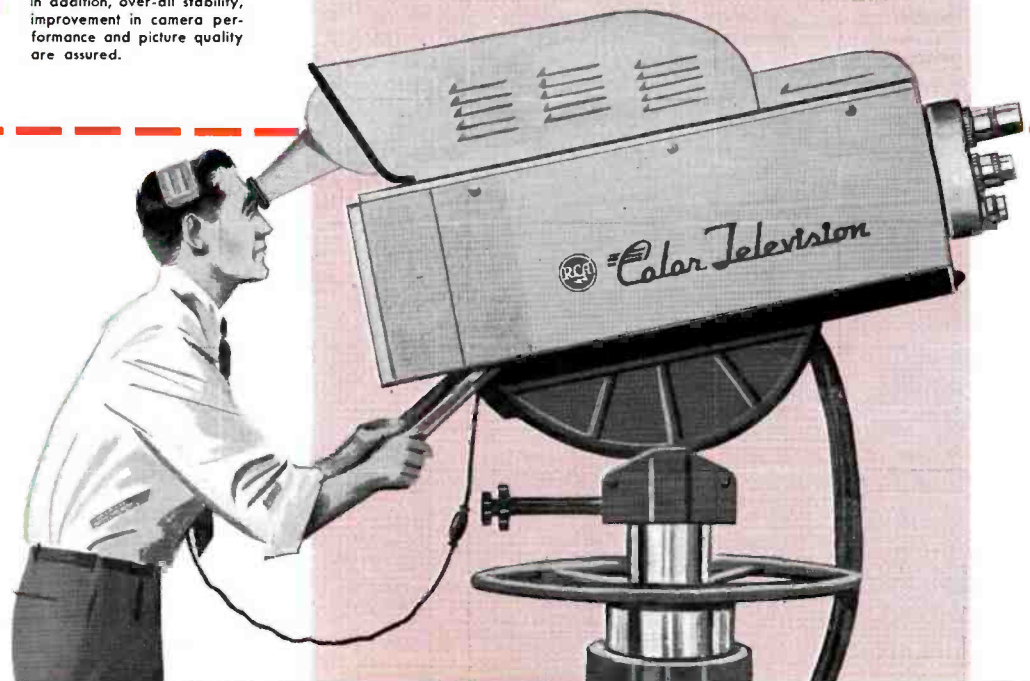



# COLOR CAMERA TV EQUIPMENT

... with the revolutionary all-electronic  
processing amplifier

which combines all  
signal processing  
functions in a  
single chassis.

12-Page Descriptive Brochure  
Available on Request.

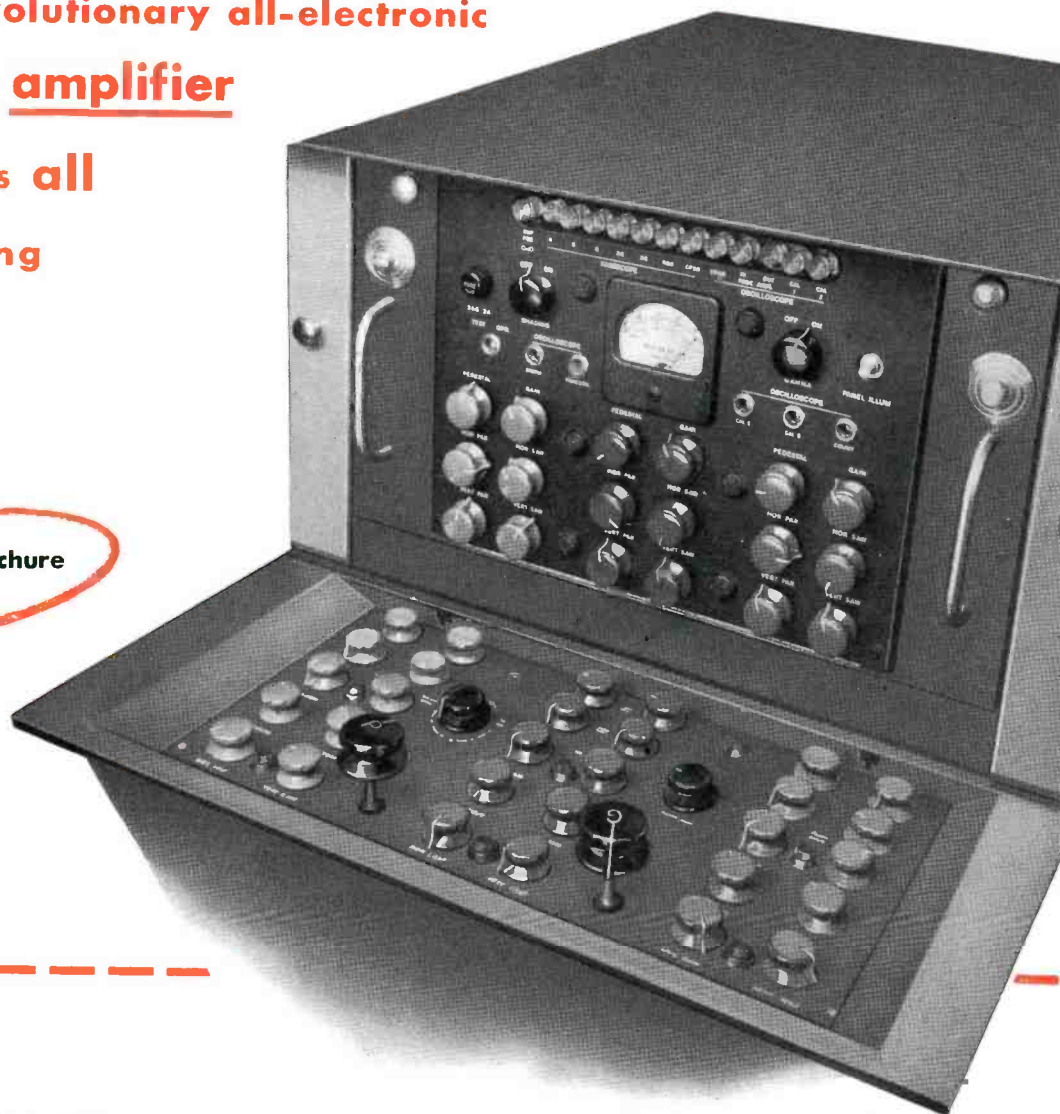

RCA Pioneered and Developed Compatible  
Color Television

View of  
Processing  
Amplifier  
with front  
shelf  
removed



**RADIO CORPORATION of AMERICA**  
ENGINEERING PRODUCTS DIVISION

CAMDEN, N.J.

# NEW...

# RCA

## All New Type

### 10,000 WATTS

*Good Color  
Performance  
Depends on These  
Specifications*

- Power Output... 1 Watt
- Differential Gain (Linearity)... 0.5 db max.
- Differential Phase Distortion (at 3.58 mc)... less than 1%.
- Amplitude Frequency Response... Flat within .3 db 60 cycles to 6 mc.
- Synchronizing Signal Compression... Negligible.
- Low Frequency Square Wave Response... Less than 1% tilt at 60 cycles.

*For descriptive literature on this newest of microwave systems or help in planning your microwave setup, consult your RCA Broadcast Sales Representative.*



# MICROWAVE

**High-Power**

## **TVM-1A designed for Color TV**

(Best for Monochrome, too)

**ERP AT 7000 MC**

---

The TVM-1A is the only microwave equipment designed specifically as an integral part of a complete color TV system . . . from color originating equipment to color receivers. Whether you're a monochrome or color user, you will appreciate these special advantages:

### **HIGH POWER**

An increase of 10 in transmitter power and about 3 db in receiver sensitivity offers 20 times the power margin of the popular RCA TTR-TRR series of microwave equipment. This means greater operational reliability with an increased fading margin.

### **SOUND DIPLEXING**

Included in the TVM-1A system is high quality audio channel for the simultaneous transmission of sound along with picture

information. This sound channel is well within FCC requirements for a studio-to-transmitter link (STL).

### **TRANSMITTER AUTOMATIC FREQUENCY CONTROL**

Transmitter AFC offers exceptionally good frequency response and highest stability. It is especially useful in multihop operation with unattended repeater stations.

### **TRANSMITTER PICTURE MONITORING**

This facility assures an actual high quality "air" signal. It simplifies trouble shooting procedures and is also extremely useful in the operation of unattended repeater stations.

*RCA Pioneered and Developed Compatible Color Television*



**RADIO CORPORATION of AMERICA**  
ENGINEERING PRODUCTS DIVISION  
CAMDEN, N.J.

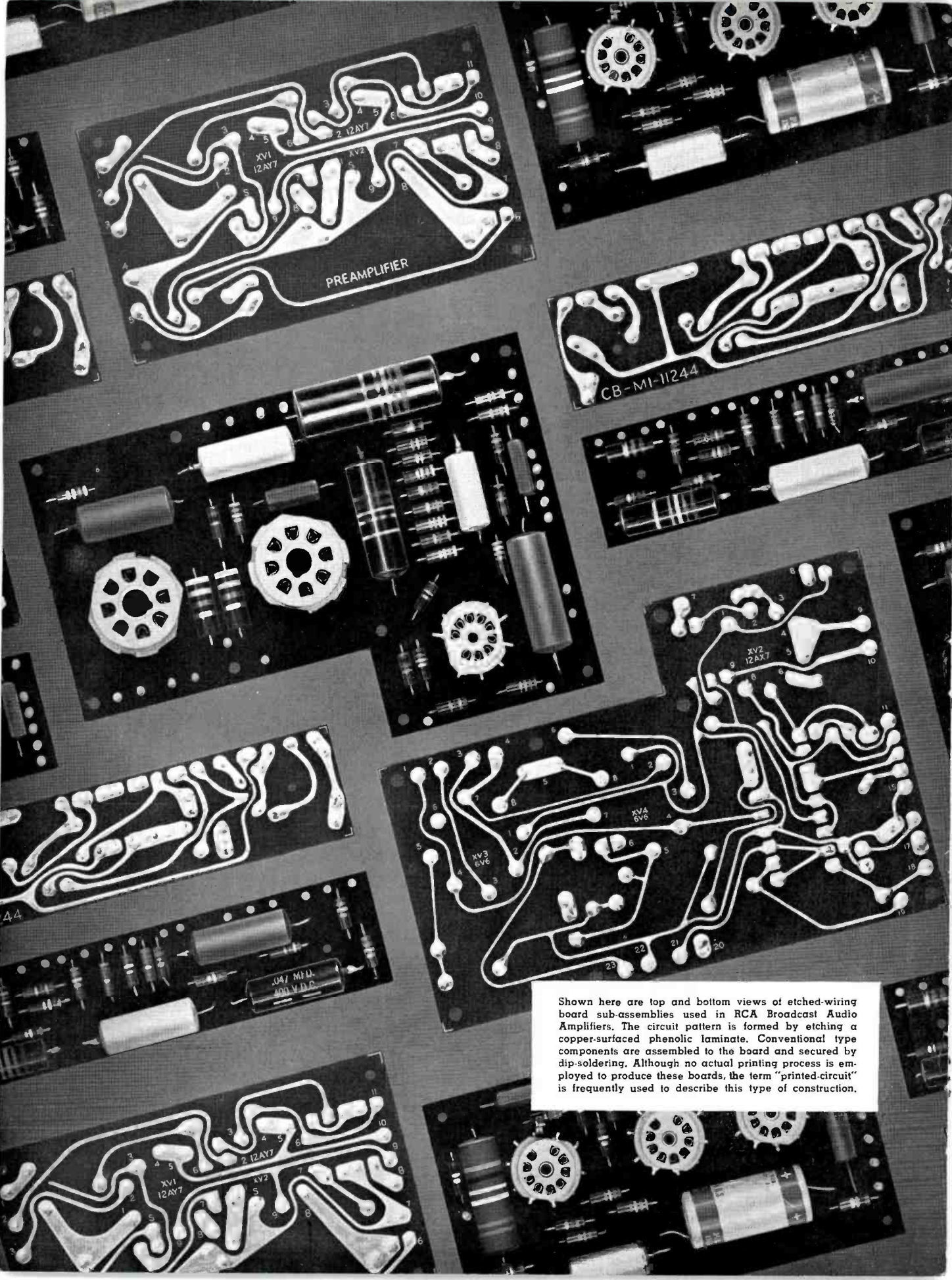

Shown here are top and bottom views of etched-wiring board sub-assemblies used in RCA Broadcast Audio Amplifiers. The circuit pattern is formed by etching a copper-surfaced phenolic laminate. Conventional type components are assembled to the board and secured by dip-soldering. Although no actual printing process is employed to produce these boards, the term "printed-circuit" is frequently used to describe this type of construction.



# MINIATURE BROADCAST AMPLIFIERS USE ETCHED-WIRING TECHNIQUE

A new line of Audio Amplifiers consisting of a Preamplifier, Program Amplifier, Monitoring Amplifier and Preamplifier Power Supply as well as a new Mounting Shelf are now available to the broadcaster. The amplifiers are shown below in Fig. 1.

This new audio equipment offers above all a considerable reduction in space requirement which is particularly important today when much new equipment must be added to already crowded space. Other improvements include better performance, greater uniformity, easier serviceability and lower power consumption.

The design of the equipment to be described is based on long experience in the design and manufacture of broadcast studio equipment. A brief review of the evolution of broadcast audio amplifiers will illustrate the steady improvement made during the last twenty years.

## Historical Background

In the early days of broadcasting, audio systems were relatively simple. The number of input and output channels was small. Consequently only a few amplifiers were required. Finding space in the control room for this equipment was no problem. Com-

by **G. A. SINGER**  
Broadcast Studio Engineering

ponents, particularly transformers and tubes, were quite bulky in those early days. The first amplifiers consequently were of considerable size.

The amplifiers were panel mounted and connections were wired directly to terminal boards on the equipment. Therefore, repairs had to be made at the rack location.

As studio layouts became increasingly complex, a reduction of amplifier size became more important. Chassis and shelf mounting provided a big improvement. This design permitted more efficient use of the depth of the equipment rack.

As stations remained on the air for longer periods of time and reliability became increasingly important, means for quick replacement of a defective unit became necessary. This feature was provided by the plug-in unit construction introduced in 1945.

The original line of plug-in amplifiers proved its worth over the succeeding years. Steady improvements were made in com-

ponents and construction without requiring changes in basic circuitry.

The expansion of television now taking place requires an even more economical use of available equipment space. Fortunately, component design has made great progress in recent years. Particularly in the field of audio transformer design, the use of improved core materials has resulted in a considerable reduction of volume. Modern tubes, resistors, capacitors and other electrical components require also much less space than comparable types of ten years ago.

Some circuit changes also permitted the use of smaller components. The application of push-pull output stages in the Preamplifier and Program Amplifier for example decreased space requirements of the output transformer and improved performance at the same time. A voltage regulation circuit in the Preamplifier Power Supply eliminated two filter chokes, a power rheostat and several large electrolytic capacitors. The reduction in rack space requirement is illustrated in Fig. 2 and a chart showing rack space requirement over the years is illustrated in Fig. 11.

FIG. 1. A group of three etched-wiring miniature Broadcast Audio Amplifiers. Left-to-right BA-21A Preamplifier, BA-23A Program Amplifier and BA-24A Monitoring Amplifier.

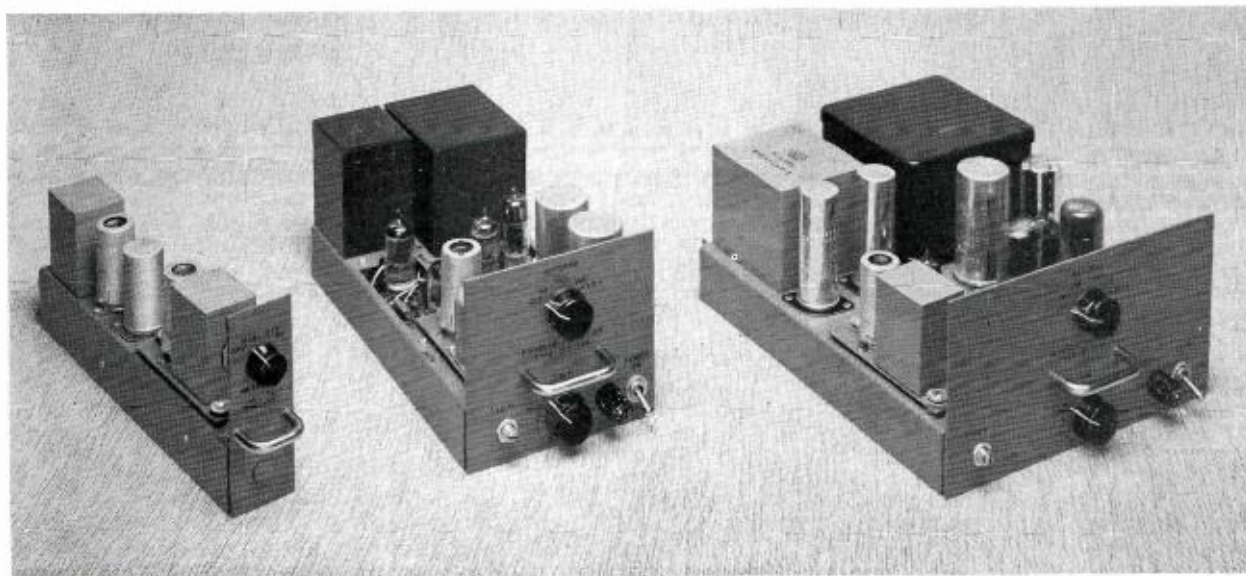



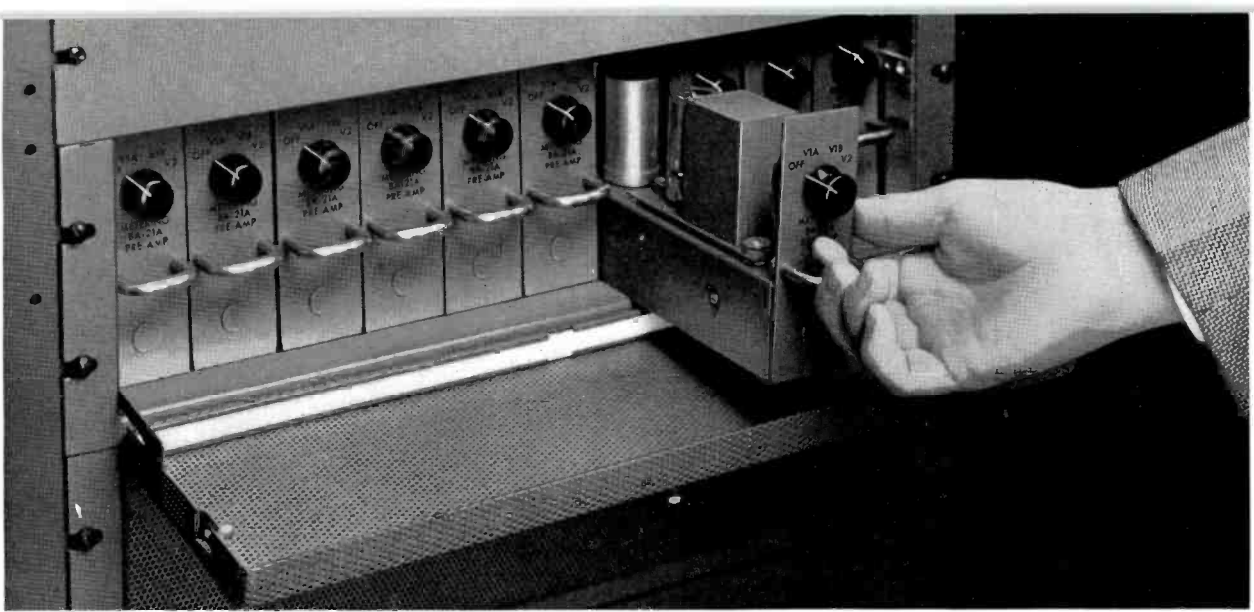

FIG. 2. Photo showing the advantage of space conservation when using miniaturized preamplifiers. Here 10 BA-21A Preamplifiers are accommodated on one shelf.

### Miniature Design

Miniaturization of electronic equipment presents a manufacturing problem, if conventional methods of assembly and wiring are used. Considerably more skill and time are required for assembly and wiring where space is restricted, than for comparable larger equipment. The effect of component and lead dress becomes more critical. Testing and replacement of components in the field is more tedious.

To avoid these complications of conventional wiring techniques, dip soldered, etched circuit boards as shown in the opening spread are used which lend themselves to mechanized or even automatic assembly. Having inherently fixed component and lead dress, greater uniformity of perform-

ance and reduced test time are obtained. Good accessibility permits rapid isolation and replacement of defective components in the field.

The circuit boards are made of a paper base phenolic laminate (NEMA grade XXXP) to which is bonded an electrolytic copper sheet. The circuit pattern is etched on this copper surface. Components are mounted by threading their leads or terminals through small holes which are punched into the board and bending them over the copper foil. Tube sockets were adapted for this type mounting by elongating and bending the terminals in "spider leg" fashion. All other components mounted on the circuit boards are of the standard uniaxial lead type which are generally

available from radio parts distributors. Electrical connections to the board are usually made to turret type terminals which are staked into the board. After component assembly, all electrical connections are made simultaneously by dipping the board, copper foil side down, into a pot containing molten solder.

At this time it is not considered practical to mount heavy components, or components subject to handling in operation, such as controls, directly to the circuit board because the stress set up in the solder connections or phenolic boards may cause failure. For this reason, audio and power transformers, large electrolytic capacitors, connector plugs, switches, variable resistors, etc., are mounted directly to the chassis. Electrical connections between these components and the circuit board are made by means of conventional wiring.

In the design of the new line of amplifiers care was taken to permit quick access to all components for test or replacement should repairs be necessary. Large cutouts in the chassis or removal of a few mounting screws permit access to both sides of the circuit board. Simple instructions for component replacement are given with each unit. A small soldering iron (25 W) should be used to unsolder and resolder component leads to the circuit board. Care should be exercised not to overheat the copper foil to avoid loosening the bond between the foil and the board.

### BA-21A Preamplifier

The BA-21A Preamplifier (Figs. 2, 4 and 5) was primarily designed for microphone and turntable use. Its high output rating of 18 DBM makes the BA-21A also suitable as a booster or isolation amplifier. It is equivalent or superior in performance

FIG. 3. A compact power supply (BX-21A) furnishes power for ten BA-21A Preamplifiers.

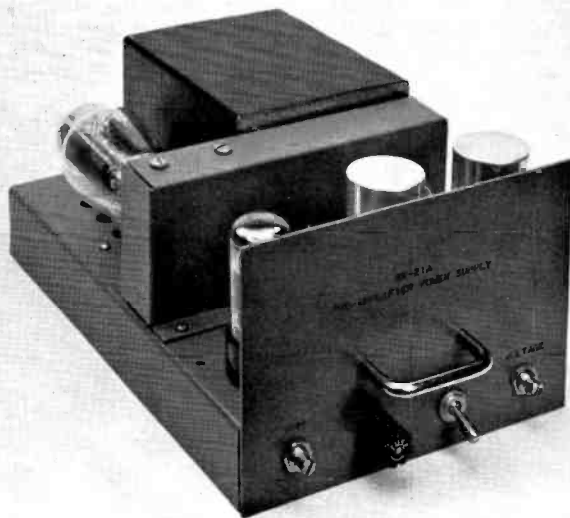

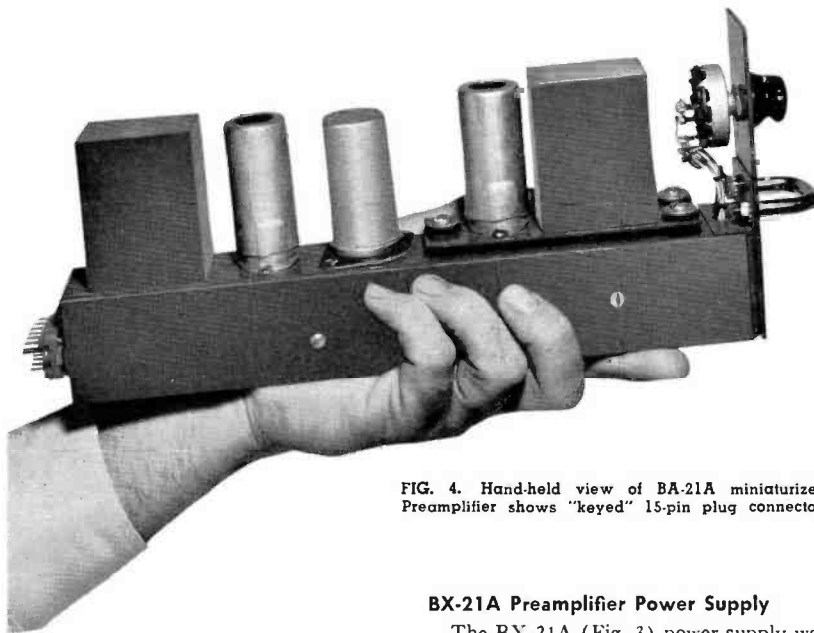

FIG. 4. Hand-held view of BA-21A miniaturized Preampifier shows "keyed" 15-pin plug connector.

#### BX-21A Preampifier Power Supply

The BX-21A (Fig. 3) power supply was designed to furnish plate and heater power to 10 BA-21A Preampifiers (6.3V—6 amps. ac and 285V—100 ma. dc). The plate voltage is extremely well filtered and electronically regulated. Once the plate supply voltage is adjusted to the desired value it will maintain this voltage, within the ratings of the power supply, with variations of load currents and line voltage. The voltage regulator circuit consists of a series regulator tube, a d-c voltage amplifier and a voltage reference tube. The regulator circuit also functions as a filter to reduce ripple to a very low value. Positive heater

to the BA-11A Preampifier yet requires only about one-third of the rack space. An unloaded input transformer is used to obtain maximum signal to noise ratio. The primary is tapped for source impedances of 37.5, 150 and 600 ohms. A selected 12AY7 tube is used for low noise in the input stage. The other half of this twin triode is used as phase splitter which drives a second 12AY7 in the push-pull output circuit. Negative feedback from a tertiary winding is applied to the cathode of the input stage to reduce distortion and stabilize gain. The output transformer may be connected to work into either a 150 or 600 ohm load. A metering switch is provided on the front panel for checking tube currents. A convenient U shaped handle is attached to the panel for easy insertion and withdrawal of the amplifier. All electrical connections are made through a 15 pin connector plug. The pins and contacts are gold plated to insure long trouble-free operation. Limitation on the size and form of the amplifier restricted the design of the etched circuit board. It was found to be advantageous to limit the components on the circuit board to resistors and coupling capacitors. The BA-21A Preampifier is only 1.625 inches wide and ten amplifiers may be mounted on one BR-22A Shelf. The amplifier requires 6.3V—0.6A ac and 285V—10 ma. dc from an external power supply. A mounting hole for installation of a bridging gain control is provided on the front panel.

bias and a hum adjustment for the preampifier heaters are provided.

A 1V metering voltage corresponding to an output voltage of 285V is available at the connector plug for wiring to a centrally located meter panel.

The BX-21A Power Supply requires 0.4 of the shelf space. It is thus possible to install 2 BX-21A Power Supplies and 2 BA-21A Preampifiers or one BX-21A and 6 BA-21A on one BR-22A Shelf.

#### BR-22A Mounting Shelf

A new mounting shelf (Fig. 5) was designed for the new plug-in units in the equipment rack. The BR-22A Mounting Shelf is only 5.25 inches high, 12.50 inches deep and fits any standard 19 inch rack. Access to the plug-in units is gained through a hinged front cover. This cover is made of perforated steel for additional ventilation. A designation strip is provided for marking the type number and system function of each plug-in unit. The front cover is easily removable if it is desired to have the controls on the front panels of the amplifiers exposed.

The new line of amplifiers and power supplies are installed on the shelf by means of a guide assembly which is furnished with each plug-in unit. See Fig. 5.

The BR-22A Mounting Shelf will accommodate the following equipment:

- 10 BA-21A Preampifiers
- or 3 BA-23A Program Amplifiers and 1 BA-21A
- or 2 BA-24A Monitoring Amplifiers
- or 2 BX-21A Power Supplies and 2 BA-21A's

FIG. 5. View showing female plug connectors and guide tracks. The shelf used to hold these amplifiers is the new BR-22A Mounting Shelf.

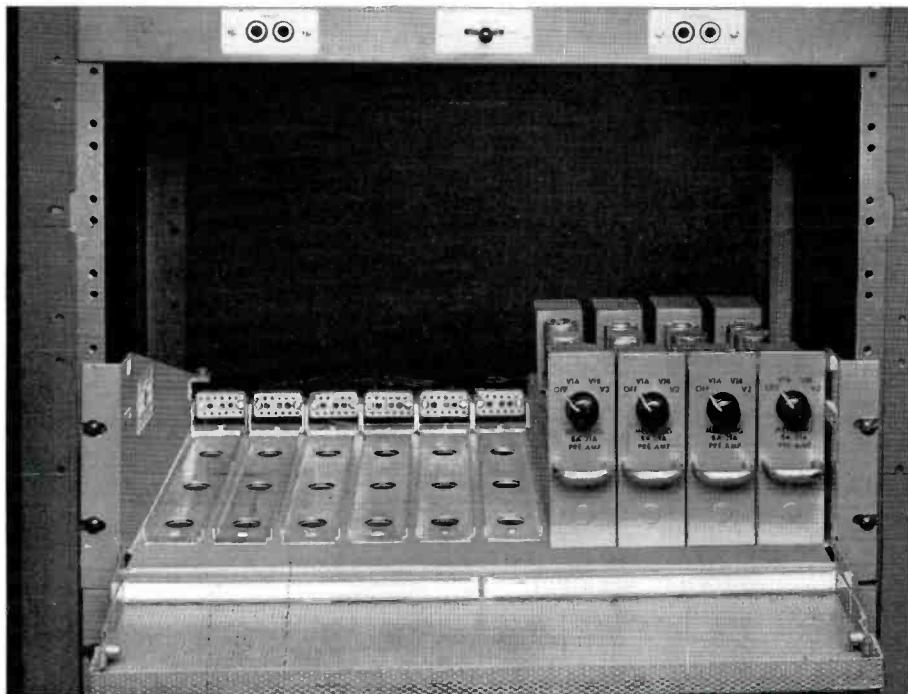





FIG. 6. View showing BA-24A Monitoring Amplifiers at NBC Studios in New York.

FIG. 7. Rear view of a bank of both BA-23A Program Amplifiers and BA-24A Monitoring Amplifiers at NBC Studios, New York

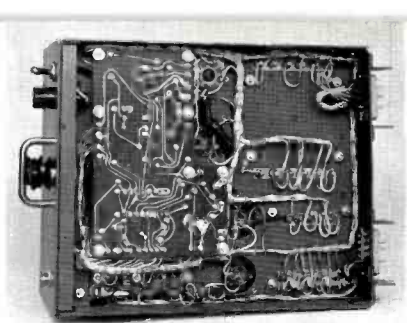
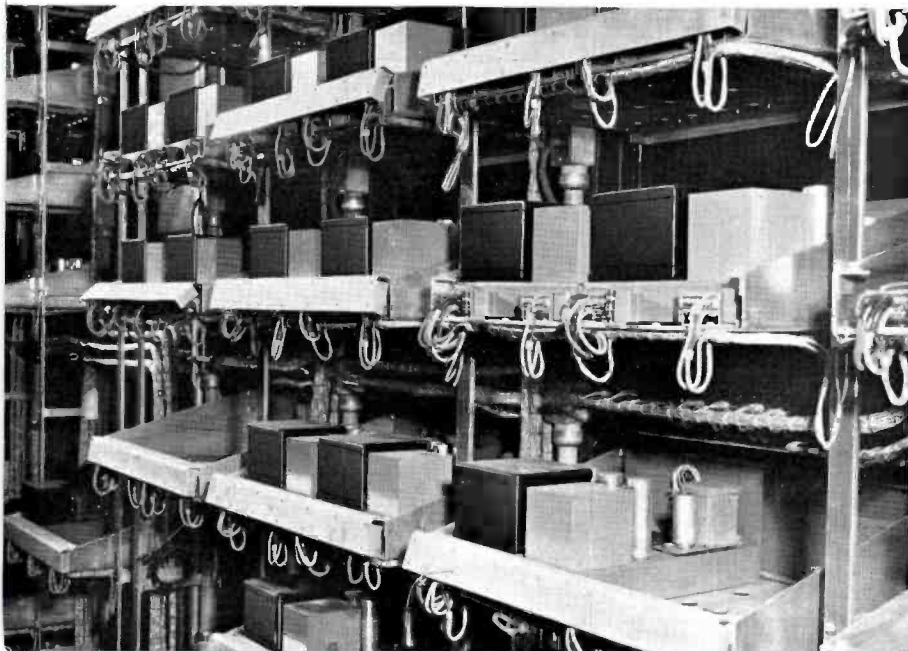

FIG. 8. Underside of a BA-24A Monitoring Amplifier. Note etched-wiring circuit board on left.

### BA-23A Program Amplifier

The BA-13A is superseded by the BA-23A Program Amplifier (Figs. 1 and 9). This is a high quality amplifier having very low distortion at output levels as high as 30 DBM. A potentiometer gain control loads the secondary of the input transformer. This arrangement permits a wide range of input levels. The input tube is a 5879 low noise pentode which is resistance capacitance coupled through a voltage divider to a 12AX7 twin triode. By changing a jumper, the voltage divider permits reduction of the maximum gain from 70 DB to 55 DB with a corresponding reduction of 15 DB in noise. It is therefore advisable to operate with the low gain connection when less than 55 DB gain is sufficient. The other half of the 12AX7 is used as a phase splitter which drives two 12AU7 tubes connected in push-pull parallel. As in the preamplifier, negative feedback is derived from a tertiary winding on the output transformer and applied to the cathode of the second stage. Input and output impedances are 150 and 600 ohms. A built-in bridging pad has an input impedance of 20,000 ohms and reduces the maximum insertion gain by 37 DB when connected. An etched circuit board contains most of the electrical components including all tube sockets with the exception of the socket for the input stage.

The power supply is self-contained with a 6X4 used as full wave rectifier. The a-c power requirement is 30 W. The controls, consisting of the gain control, hum adjustment, metering switch, power switch and a fuse holder are located on the front panel. The BA-23A Program Amplifier requires 0.3 of a shelf space. Thus, one may mount three BA-23A Program Amplifiers on one BR-22A shelf with space available to accommodate one BA-21A Preamplifier.

### BA-24A Monitoring Amplifier

The BA-24A Monitoring Amplifier has sufficient gain (104 DB) to obtain full output of 8 watts when connected directly to a microphone or turntable. Its excellent frequency response and low distortion make the BA-24A ideally suitable not only for checking the quality of program trans-



mission but also as a driver amplifier for disc recording cutters and as a program or line amplifier where higher than normal output levels or gain are required. Views of the BA-24A are shown in Figs. 1, 6, 7 and 8.

The input signal is applied through an unloaded input transformer to the grid of one section of a 12AY7 twin triode. The plate is resistance-capacitance coupled through a gain control to the grid of the other section of the 12AY7. This tube is in turn R-C coupled to one section of a 12AY7 twin triode while the second section is used as a phase splitter which drives two 6V6-GT tubes connected in push-pull. Negative feedback from a tertiary winding on the output transformer is applied to the cathode of the preceding stage. The output transformer secondary winding is tapped

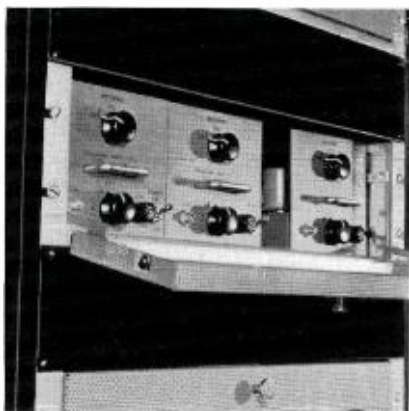

FIG. 9. Three BA-23 Program Amplifiers on BR-22A Mounting Shelf at NBC.

for load impedances of 4, 8, 16, 150, and 600 ohms. On the front panel are located the gain control, hum adjustment, metering switch, power switch and fuse molder. The power supply is self-contained, utilizing a 5Y3-GT tube in a full wave rectifier circuit. The majority of electrical components are assembled on an etched wiring board. The chassis is 8.375 inches wide, thus two BA-24A amplifiers are accommodated on one BR-22A Mounting Shelf. See Fig. 6.

#### Advantages of Self-Contained Power Supplies

There are certain advantages to having self-contained power supplies in the program and monitor amplifiers over external supplies which furnish power to several amplifiers. These advantages are:

1. Greater reliability
2. Greater flexibility
3. Simpler wiring

#### SUMMARY OF AMPLIFIER CHARACTERISTICS

| Type .....                 | BA-21A        |                      | BA-23A               |                         | BA-24A                   |
|----------------------------|---------------|----------------------|----------------------|-------------------------|--------------------------|
|                            | PREAMPLIFIER  |                      | PROGRAM AMPLIFIER    |                         | MONITORING AMPLIFIER     |
| Name .....                 | MI-11244-A    |                      | MI-11246-A           |                         | MI-11247                 |
| Stock Identification ..... |               |                      |                      |                         |                          |
| Usage .....                | Pre-Amplifier | Isolation Amplifier* | Program Line Amp.    | Bridging Isolation Amp. | Monitor-Record Amplifier |
| Max. Gain .....            | 40 ±1 DB      | 4 ±2 DB              | 70 ±1 DB             | 33 ±2 DB                | 104 ±2 DB                |
| Max. Input Level .....     | -22 DBM       | 40 DBM               | -10 DBM              | 40 DBM                  | -30 DBM                  |
| Rated Output Level .....   | 18 DBM        | 18 DBM               | 30 DBM               | 30 DBM                  | 39 DBM                   |
| Input Impedance .....      | **            | 10,000 Ω             | 150/600 Ω            | 20,000 Ω                | **                       |
| Source Impedance .....     | 37/150/600 Ω  | 600 Ω                | 150/600 Ω            | 600 Ω                   | 37/150/600 Ω             |
| Load Impedance .....       | 150/600 Ω     | 150/600 Ω            | 150/600 Ω            | 150/600 Ω               | 4/8/16/150/600 Ω         |
| Frequency Response         |               |                      |                      |                         |                          |
| 30-15,000 CPS .....        | ±1 DB         | ±1 DB                | ±1 DB                | ±1 DB                   | ±2 DB                    |
| Power Requirement .....    | 6.3V—0.6A     | A-c***               | 100-130 V, 50-60 CPS |                         | 100-130 V, 50-60 CPS     |
|                            | 285V—10mA     | D-c****              | 30 W                 | 30 W                    | 70 W                     |
| Mounting Space**** .....   | 0.1           | 0.1                  | 0.3                  | 0.3                     | 0.5                      |

\* With MI-11278-E (Knob) or MI-11278-F (Screw Driver Slot) Bridging Gain Control.  
 \*\* Unloaded Input Transformer, Input Impedance substantially higher than Source Impedance.  
 \*\*\* The BX-21A Power Supply will supply power to 10 BA-21A Preamplifiers.  
 \*\*\*\* On BR-22A Mounting Shelf.

FIG. 10. Table Summary of Amplifier Characteristics.

With a common power supply, a failure of the supply or a short circuit in one of the amplifiers or the wiring will result in disabling of every amplifier which derives power from this supply. With individual supplies, failure of one amplifier or power supply will not affect the performance of other amplifiers. The self-contained power supply also eliminates the need for balancing the load of the power supplies. The addition of one new amplifier will not necessitate the addition of a new power supply when the existing power supplies are loaded to capacity.

External power supplies require wiring of plate, heater, metering and ground circuits. Elaborate cross connections, sectionalizing, switching or standby facilities are required for emergency operation in case of a power supply failure.

#### Conclusion

It has been shown that the new line of miniature amplifiers require only a fraction of the rack space of older amplifiers. This

means that in an older station much valuable rack and floor space can be gained by replacing the older audio amplifiers with the new miniature line. To the station ordering new equipment, miniaturization means that fewer racks and shelves are needed, thus reducing equipment and installation costs.

The new amplifiers also are more efficient and therefore require less power to operate. This means a saving in electric power and air conditioning costs.

A carefully planned tube complement means that replacement tubes will be readily available for many years at low cost and that a minimum of tube types have to be carried as spares.

Only high quality components are used to insure long and reliable service.

Broadcasters will find that the new line of miniature audio equipment has features tailored to fit their present and future requirements and marks an important advancement in audio equipment design.

FIG. 11. Chart showing yearly progress in amplifier space conservation.

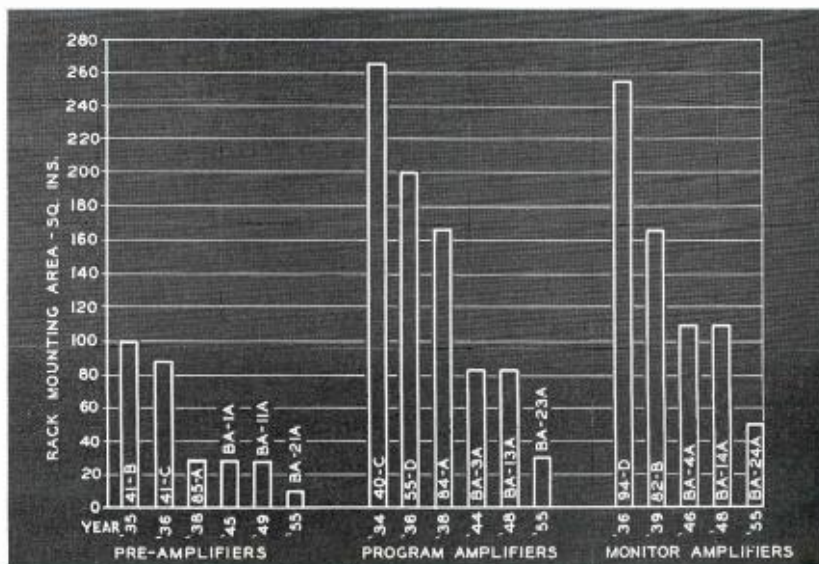



**The 3-V System Is Easy to Set Up and Maintain, Simple to Operate**

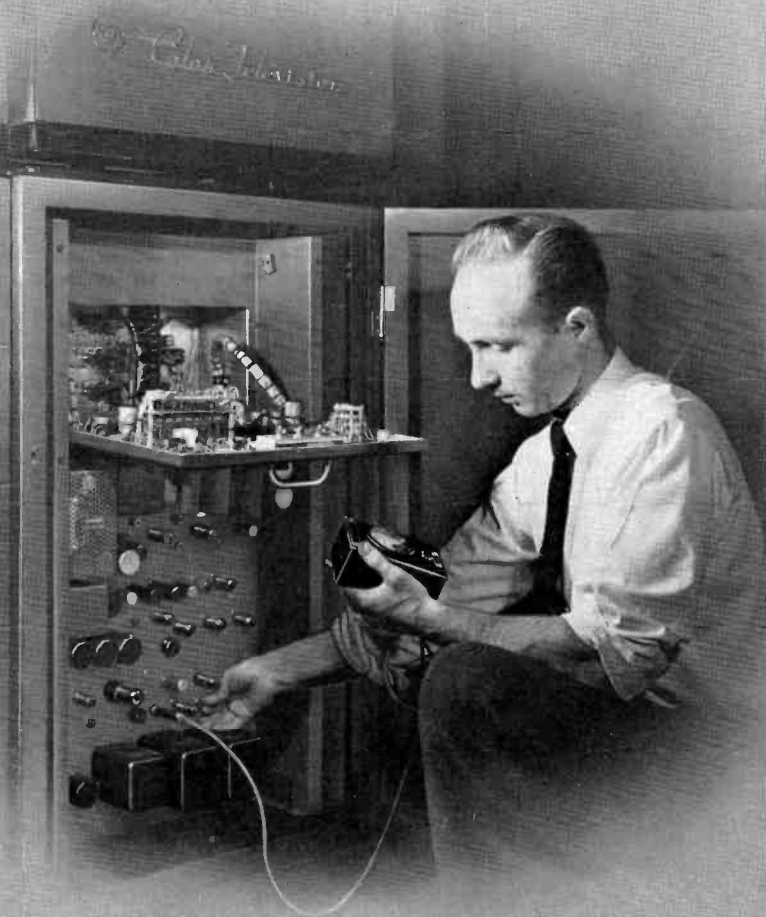



# THREE VIDICON COLOR FILM SYSTEM

## Introduction

With the advent of color television the proper reproduction of film assumes a role as great or greater than that played by film reproduction in monochrome television. It was apparent that during the introductory period of color television, a great number of stations would use network facilities, where available, for live color programming but would wish to originate their own color film programming in addition. This would allow them to run their own color commercials and local interest material which are very important to a station's operation.

With this in mind a very extensive program has been carried on by RCA for several years to develop and market the best system possible for the reproduction of color film. In the course of this development the following four methods were studied, tested, and evaluated by engineers at the David Sarnoff Research Center, Princeton; RCA Engineering Products Division, Camden; and NBC, New York. The processes include both basic kinds of pickup devices, storage and non-storage.

by

**K. H. HARDIMAN**

**N. L. HOBSON**

**B. F. MELCHIONNI**

**A. REISZ**

**RCA Television Engineering**

Iconoscopes, image orthicons, and vidicons are all storage devices in which light information from the scene may be stored for a time in the form of a varying electrical charge on a surface and then picked off at a later time by a scanning process even though the light may have been removed. Non-storage devices are typified by the flying-spot scanner. In such devices light must be present at the moment of scanning. This is equivalent to saying that the optical image must be stationary throughout the entire interval of scanning.

### **I. Flying Spot Scanner with Intermittent Projector**

The Flying-Spot Scanner is a non-storage device. Basically, the system uses a kinescope as its light source. The scanned raster

on the kinescope face is imaged at the film plane by a lens system. This means that any point on the scanned raster represents a particular point at the film plane. Light emitted by the kinescope passes through the film and by an optical system is split into its three color components. These are picked up by three photo-electric cells to produce electrical signals. Since this is a non-storage type of operation, the film must remain optically stationary with respect to the scanning raster at all times during the scanning interval.

If an intermittent type of projector is used, the pulldown of the film must take place during the vertical blanking interval. Even though this interval is comparatively short, a projector was designed by RCA<sup>1,2</sup> to do the job and operated very well. However, special care was required in splicing and film handling.

The lack of a red photocell with high enough sensitivity, limits the signal-to-noise ratio and, therefore, the light reserve in the system. This system requires that the projector be run synchronously with the vertical scanning in the TV system.



## II. Flying Spot Scanner with Continuous Projector

Another method of keeping the film stationary with respect to the scanning raster is to construct an optical system that maintains the image stationary by means of revolving optics. This has been done by the use of rotating prisms, rotating mirrors, oscillating mirrors, etc., but each approach is limited by the extreme accuracy required in its manufacture.

## III. Storage Tube with Intermittent Projector (System Finally Adopted)

Because of the excellent performance of the vidicon in reproduction of monochrome pictures,<sup>3</sup> and because of its geometrical simplicity (at least as compared to the iconoscope), this tube was selected as the one most likely to give the best quality of performance in color. It is outstanding from the standpoint of reliability and low cost of operation. Because of its excellent storage characteristics, information may be stored during one interval and removed at a later interval of time. Tests have shown that storage may actually take place during part of the scanning interval with no detrimental effects. This feature permits non-synchronous operation of the projector with respect to the scanning interval without any noticeable shutter bar.

When used with a standard 2-3 intermittent television projector, it permits opening of the shutter for maximum light. The only limitation here is that the shutter must close during the time the film is in motion.

FIG. 2. Plan view of typical 3-V color film system.

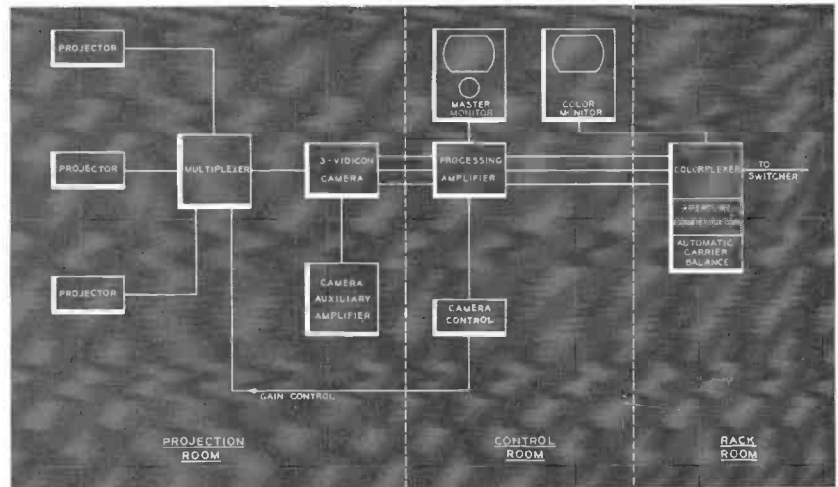

FIG. 1. Block diagram of 3-vidicon color film camera chain.

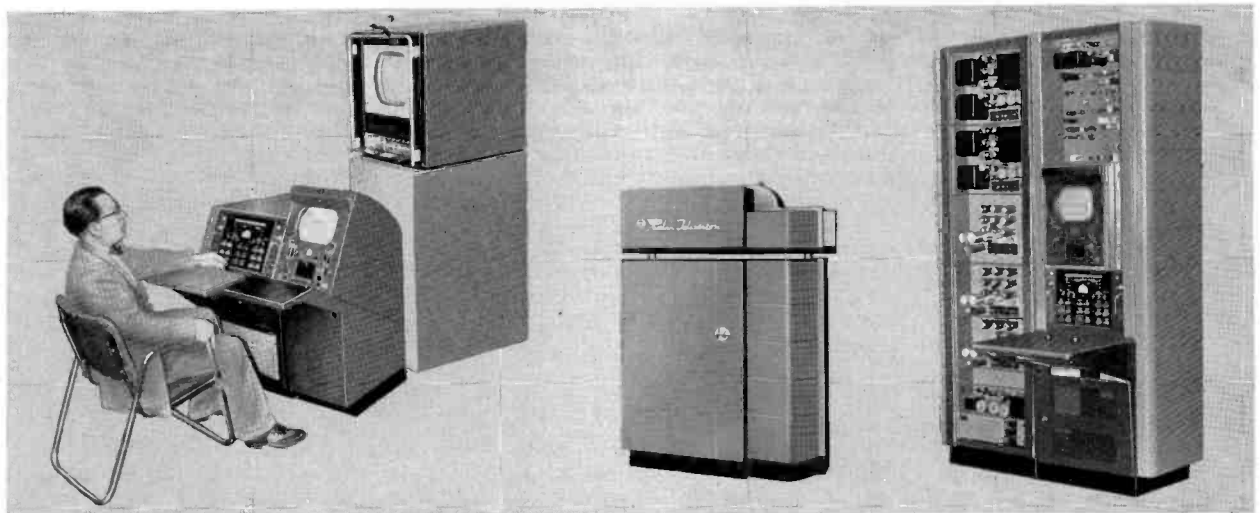
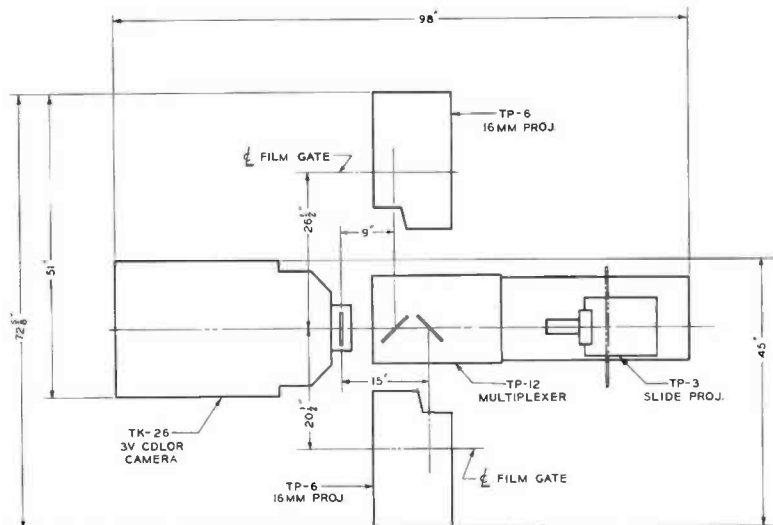

FIG. 3. Equipments included in complete 3-V color film chain: (left) Control equipment, (center) Color Film Camera, (right) Colorplexer, aperture compensators, and power supplies (in racks). In extreme right rack is an alternate method of mounting control equipment (monitor, processing amplifier, etc.).

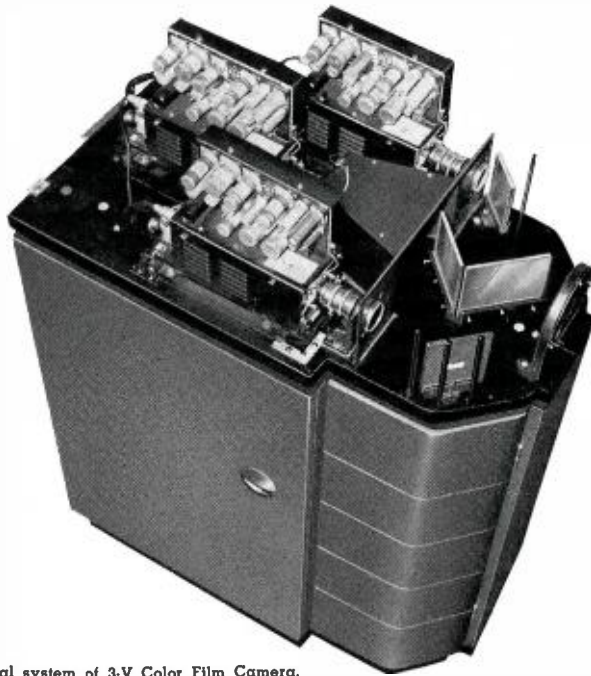

FIG. 4. Optical system of 3-V Color Film Camera.

#### IV. Storage Tube with Continuous Projector

This system is essentially the same as that described in III, Page 16, except for the projector. As has been pointed out previously, the limitations here are in the manufacture of a high quality continuous projector.

##### Features of 3-V System

An over-all block diagram of the 3-V system is shown in Fig. 1. The floor space taken by the equipment in the projection room is essentially that required by existing monochrome installation and is shown in Fig. 2. The camera may be operated with as much as 200 feet of cable between it and the control equipment (Fig. 3).

The factors contributing to the excellent results obtained with the monochrome vidicon camera are:

1. Excellent signal-to-noise ratio, allowing a large amount of aperture correction.
2. 600 line resolution capability.
3. Good black level information.
4. Low inherent gamma permitting a large range of illumination.
5. Simplicity of adjustments.
6. Long tube life.

These factors form many of the prime reasons for excellent results obtained from the color film chain. The color film camera is essentially three monochrome vidicon cameras that are accurately registered to form a single image. The problem of ac-

curate registry of three images was readily solved by the new design of a precision deflection assembly for the vidicon.

Features of the three vidicon system, in addition to those previously mentioned for monochrome, are:

1. Superposition resolution capabilities: 600 lines/center; 400 lines/corner.
2. Accurate color separation.
3. Ample light reserve for dense film.
4. Excellent monochrome pictures from a color transmission.
5. Non-synchronous operation with intermittent projectors.
6. Easy application to multiplexing with several projectors.
7. Precision deflection components minimizing registration errors.
8. Stabilized circuits to minimize drift.
9. Vernier registration controls for accurate adjustment.
10. Duplicate controls provided at the local position for ease of setup.
11. Bridging pulse inputs, with only one input each for horizontal drive, vertical drive and blanking.
12. Drive pulses independent of incoming amplitude and duration.
13. Several plug-in units for ease of servicing and minimum "down" time.
14. Variable neutral density filter used to control light to assure a high and constant signal-to-noise ratio.
15. Essentially only one operating control (master gain control).

#### Optical Assembly

The upper portion of the camera is the Optical Assembly and might be truly called the heart of the system. It is within this unit that the light is split into primary components and converted into electrical signals to send to the Processing Amplifier.

In order that any optical system may fulfill its requirements faithfully with time, it must be kept clean. To assure this result, the cover for the optics was constructed to be dust tight.

In an effort to minimize down time the three camera subchassis (which are identical) are easily removed by loosening two screws and removing three cables on each. This facilitates changing the vidicon tube or the camera subchassis. Three-point suspension of the optical assembly, readily accessible from the top, is used for ease of initial adjustment. The physical appearance of the optical system can be seen in Fig. 4.

Provisions have been made to mount standard size neutral density filters in each light path where required such that the sensitivity of each channel is adjusted to give the best signal-to-noise ratio.

A special camera lens was designed for flat-to-flat imagery between field lens and the vidicon photosurface. This lens is also designed for a larger image size than the standard 16mm lens in order to take advantage of the maximum resolving capabilities of the vidicon photosurface. Each lens is calibrated to its exact focal length and is positioned along a calibrated scale so that the optical images produced by all lenses are exactly the same size. This permits complete tube interchangeability without fear of having raster burns of different sizes.

A tally light is provided on the uppermost portion of the unit so as to be easily visible to the projectionist.

As in the 3-image orthicon live color camera, a relay lens system is used to provide adequate space for the optical elements which accomplish the color separation (dichroic mirrors and filters). Fig. 5 shows an elementary relay optical system and compares it to a simple projection system. It will be seen that two new elements have been added, a field lens and a relay lens. The field lens is placed at the first image plane, and it must be slightly larger than the image formed there. Its function is to bend all the rays of light from the projection lens so that they will enter the relay lens. The relay lens will then reproduce, at the second image plane, the image



formed in the plane of the field lens. Although not shown in Fig. 5, the space between the field lens and the relay lens is used for mounting the light-splitting and color-separating mirrors and filters.

In the 3-V system, the relay lens (there are actually three of them, one for each camera) is mounted just in front of the camera immediately in front of the vidicon tube. This lens is referred to as the camera lens in other parts of this article.

Fig. 6 is a block diagram of the actual optical system in the 3-V equipment. Light entering the camera from the projector passes through the field lens and approximately 50% of it is split off to the right side of the camera to the green channel by a neutral dichroic. This light reflects from a front surface mirror and is trimmed by a set of filters to the required spectral response. This mirror, and a similar one in the blue channel, are adjustable so that the internal optics of the camera may be easily and accurately aligned.

The portion of the light passing through the first dichroic strikes a second dichroic which has been designed to reflect in the blue portion of the spectrum. This reflected light is further trimmed by a set of filters in the blue channel.

The remaining light in the center channel is trimmed to give the required red response.

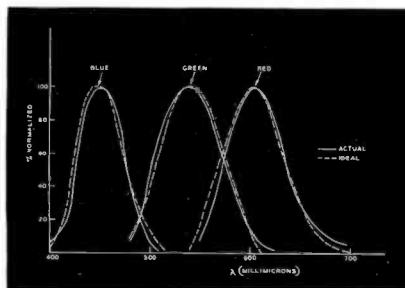

FIG. 7. Actual 3-V camera sensitivity response compared to the ideal.

Fig. 7 shows the actual camera sensitivity curves as compared to the ideal camera sensitivity curves.

#### Camera Subchassis (Fig. 8)

Three identical and therefore interchangeable camera subchassis are used to receive the three spectrally separated optical images. Each performs the same function of converting its particular optical image into a television signal which can be

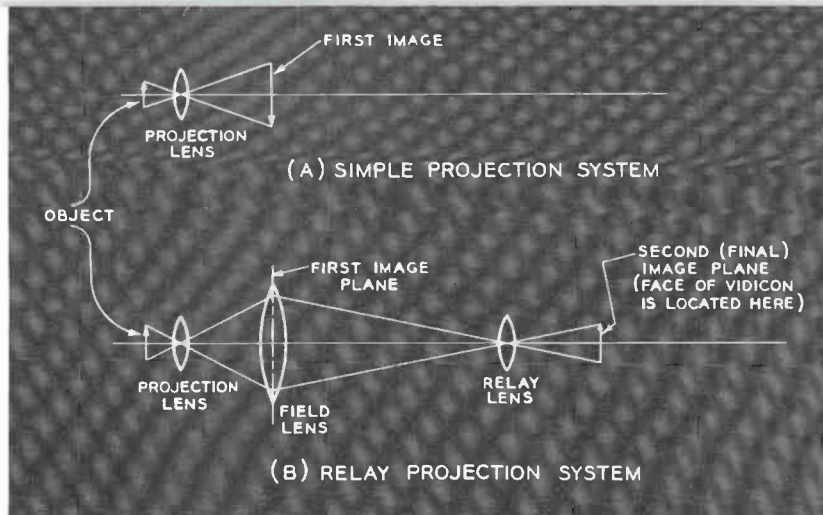

FIG. 5. Comparison of simple projection and relay projection optical system.

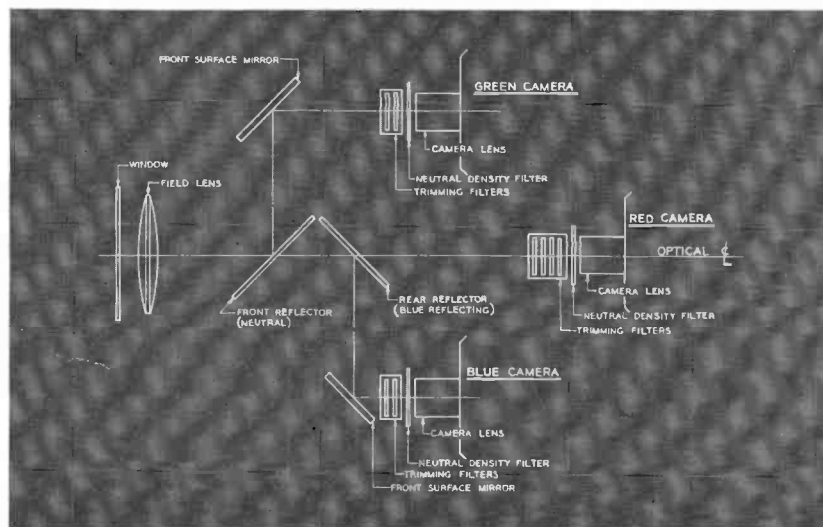
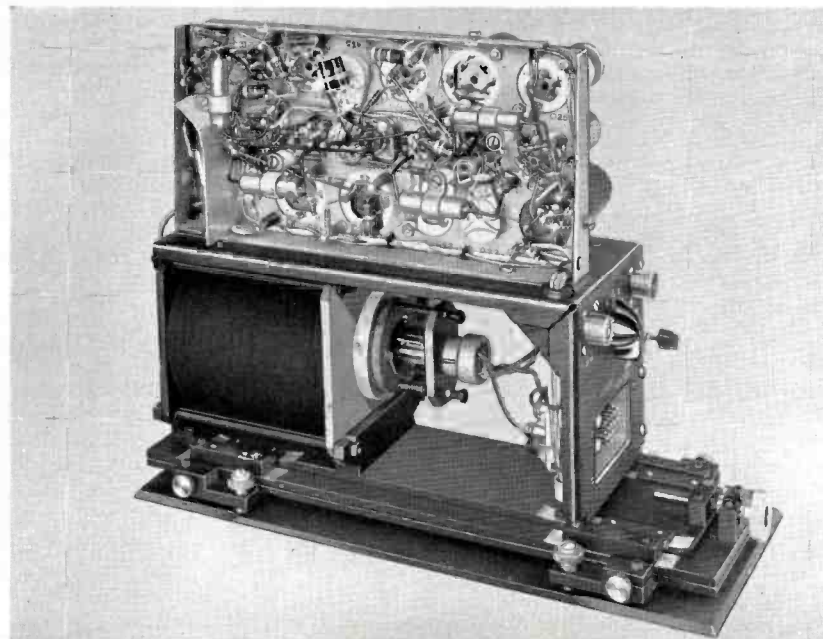

FIG. 6. Optical system of 3-V Color Film Camera.

FIG. 8. A camera sub-chassis. Note positioning of vidicon to permit accurate alignment and adjustment.



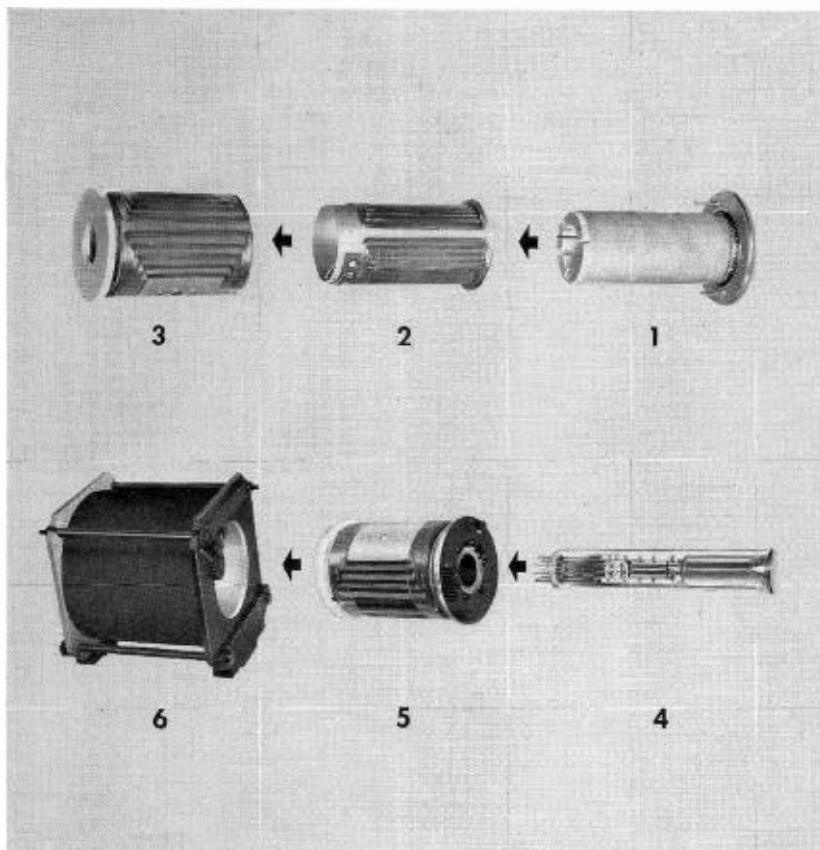

FIG. 9. Precision deflection assembly for Vidicon that assures accurate registration of images. (1. Mandrel assembly, 2. Horizontal deflection coil assembly, 3. Vertical deflection coil assembly, 4. 6326 vidicon tube, 5. Yoke assembly, 6. Focus coil assembly. Item 5 is made up of items 1, 2 and 3. Items 5 and 6 constitute a deflection assembly.)

readily transmitted to the processing equipment for synthesizing and encoding into the final composite color television signal.

Many requirements must be adequately met, of course, before the ultimate success in the form of a true and satisfying reproduction of the color film material is attained. These requirements include adequate detail rendition, signal-to-noise ratio, registration of the three simultaneous images, stability, gray scale reproduction, lack of spurious signals, sensitivity, and ease of operation. The 6326 vidicons, as supported by the associated equipment of the TK-26A, meet these requirements very well.

Good shielding of the input circuit allows the desired signal of about 15 millivolts level to enter the preamplifier essentially free of spurious signals. The high transconductance W.E. 417A together with a 12B4 comprises a high-gain, low-noise cascade amplifier to provide a high signal-to-noise ratio. Only a minimum of capacity shunting the load resistor was tolerated to reduce high peaking requirements and to

minimize shot noise in the output. An additional amplifier feeds a cathode-follower high-peaking stage driver. This configuration permits the single-stage cathode high peaker to compensate properly for high frequency losses in the input circuit through the entire 8 mc design bandwidth. A feedback output pair provides duplicate but isolated outputs at a 0.45 v normal level with excellent linearity. The two outputs have sending-end termination and are used to feed the processing amplifier and a local monitor. Current stabilization, feedback, and precision components stabilize gain so that  $\pm 1$  db gain differential between units is achieved in practice. Proper operation of the unit is premised on source light being varied until peak whites in the film material represent closely 0.3  $\mu$ a peak beam current, 15 millivolts peak-to-peak signal output, 0.45 v black to white excursion out of the preamplifier, and of course, standard input to the colorplexer, all insuring a constant and excellent signal-to-noise ratio.

Registration of three images of 0.62" diagonal to obtain horizontal definition (as

seen on a wide band monitor) of a minimum of 500 lines in the center and 300 lines in the corners, for the superimposed display presented a formidable design problem. This condition had to be readily attained and easily maintained. Complete registry requires equal over-all sizes, linearities, and rotational tracking. These were accomplished.

The vidicon tube is accurately positioned in the center of the deflection-focus-alignment components and indexed longitudinally by a precision retaining nut. This assures that the three vidicons will be positioned quite similarly with respect to the necessary focus, alignment, and deflection magnetic fields. Extensive degrees of freedom designed into the precision focusing base, which in turn is accurately indexed to the machined optical bedplate supporting all camera subchassis and the optics, permit necessary motion of the vidicon into its optimum position without disturbing its position in its deflection components. It can be angled and tilted until its photosensitive surface is accurately perpendicular to the optical axis and moved along the optical axis until uniform optical focus is obtained. Side-to-side and up-and-down motion of the camera, maintaining focus and perpendicularity with the optical axis, permits selection of the best photosensitive area (normally the center), and provides the obvious advantage of removing any signal-electrode or mesh-blemish near the edge of the area used. The lens stays in place, accurately aligned with the optical axis.

Rotational freedom of the entire yoke assembly is provided for precise orientation of the three images. Vernier motion of the vertical coils with respect to the horizontal coils is provided to first skew one image for perpendicularity of horizontal and vertical lines of the image and then to skew register the other two units. Precision construction of the yokes and focus coils (these are universal-wound) together with heavy ferrite-ring magnetic shielding further assures ease of reproduction. Yokes are driven in parallel and the focus coils are connected in series to a well regulated current source. Small differential deflections are provided (Fig. 9).

This all sounds complex and it is, of course, but once set up almost all of the foregoing adjustments are permanently made and need no further attention—the important point being that all needed variables are at command so that a superior result is readily attained with almost no need to compromise.



## Pedestal

This unit provides a stable support for the Optical Assembly and houses the Camera Auxiliary chassis. Provision is made for mounting this chassis in either side of the pedestal for the convenience of the operator. The four doors on the pedestal are mounted by split hinges such that they may be readily removed. Four bolt slots are provided in the base for anchoring the units solidly to the floor. (Fig. 10.)

## Camera Auxiliary

This unit containing circuits and functions common to all three camera subchassis is mounted in the pedestal below with flexible interconnections. One interconnection bracket receives a-c, d-c power from the power supply room, camera cables, tally cable, and local monitor coaxial cables from the camera subchassis, and the remote control cable and synchronizing signals from the remote control position. A hinged local control panel (Fig. 11) permits operation at the film position for setup and easy servicing. One man can set the camera up, then merely flick the "remote-local switch" to "remote" which transfers operating controls to the operating console (or rack) for final adjustment of the chain.

A monitor amplifier circuit supplies a wide band signal into a 75 ohm line to a local film room monitor with pushbutton selection of red, blue, green, or superimposed pictures for setup, checking, testing, or continuous monitoring. System blanking is added to this signal (camera outputs don't normally contain accurate framing information) so that the "on-air" picture edges are properly defined. An extra loop-through input connection is available on the same switcher so that any other signal such as the "on-air" picture for cuing or the colorplexer output can be readily selected on the same monitor.

Vidicon blanking, which cuts off the beam during scan return for the dual purpose of preventing image erasure and establishing black reference for accurate d-c restoration, is provided by a multivibrator. This circuit is keyed by locally regenerated horizontal drive but made inoperative by locally regenerated vertical drive to supply the composite camera blanking waveform. Clipping action and a cathode follower output stage provide a perfectly clean blanking waveshape pedestal so that this a-c portion of the signal electrode voltage does not cause spurious sensitivity variations in the outgoing signal.

Vertical deflection drive is deliberately delayed by about 300  $\mu$ /sec. and then re-



FIG. 10. Pedestal assembly supports optical system and houses camera auxiliary chassis.

generated at normal width in this unit to eliminate an otherwise characteristic white line at the bottom of the reproduced image. The new drive signal then drives the blanking circuit, as mentioned, and also the deflection circuit. The output system, involving feedback, drives the three parallel ver-

tical yokes through a 10/1 transformer with deflection current easily linear within  $\pm 1$  per cent. Time constant and voltage return controls on the sawtooth generating circuit provide local and remote over-all size control, respectively. The green camera, considered as the reference, has a fixed resistance in series with its yoke, while the other two have high resolution (vernier) trimming potentiometers for easy vertical-size image registration. Electrical centering of the scanned raster in each case is provided by a circuit made particularly stable by reference to system-regulated voltage and extremely low temperature-coefficient series resistance. Control is wide, but vernier for easy, precise setting. The parallel yokes are a-c coupled to block d-c centering current from the output transformer so that linearity is unaffected by centering considerations.

Horizontal drive is regenerated into a wider pulse within the unit to improve deflection efficiency and to preserve linearity, once adjusted, by making the unit insensitive to incoming drive variations. Spiking, feedback, and damper drive amplitude control yield stable linearity better than  $\pm 1$  per cent. Time constant and sawtooth generator voltage return controls again provide local and remote size variation. Operation of the damper and driver stages in series for d-c, with a-c coupling to the yokes, removes d-c core biasing in the 12/1 output transformer. Electrical centering is again regulated, stable, and with vernier control.



FIG. 11. Local control panel.

Focus field current for the three precision series coils is well regulated and free of temperature drift. Alignment current is equally well regulated and stabilized so that the six specific currents can be individually adjusted with negligible interaction and drift. Both regulator circuits are readily metered at the jacks provided. Likewise both are referenced to an internal voltage source so that these critical circuits are unaffected by minor adjustments in the power supply room. A relay protection circuit reduces focus current to a minimum for extra deflection and overscan should failure occur in the  $-105$  v supply. Otherwise underscan would occur with bias supply failure which could damage the vidicons.

In a similar vein, the vidicons are protected against either horizontal or vertical deflection failure by a protection circuit which acts to remove scan by biasing off the accelerating electrode upon either vertical or horizontal scan loss by sampling both deflections as near as practical to the yoke itself.

A signal electrode metering circuit is switchable between camera units for evaluation of voltage and current. Current measurements because of the low levels, have the attendant provision for zeroing out any leakage current for an accurate average beam current indication.

A regulated  $-105$  v supply provides necessary bias and control voltages and a tally relay operates from a  $24$  v d-c supply to energize an a-c lamp at the top of the camera for "on-air" indication.

#### Camera Control Panel (Fig. 12)

A remote-local switch permits complete local control panel operation for setup and servicing, eliminating much back and forth travel and communication from film room to control room position, while providing for all necessary functions at the operating position for final adjustment and operation. For example, once proper adjustment is established at the local position and switching is made to remote or normal operation, the following steps are required to reproduce the film room result and to get into operation:

1. Adjust the remote signal electrode voltage controls on the processing amplifier meter to those previously established at the local control position.
2. Merely adjust the remote beam controls for highlight discharge and the same beam current and signal level prevail.

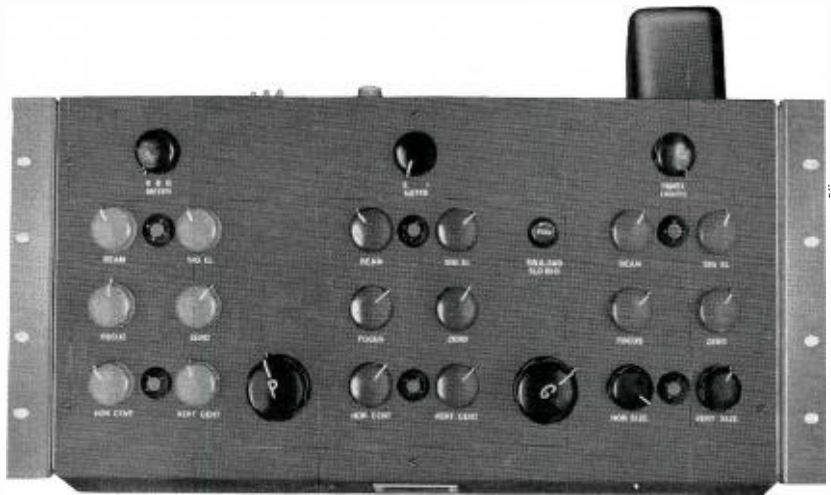
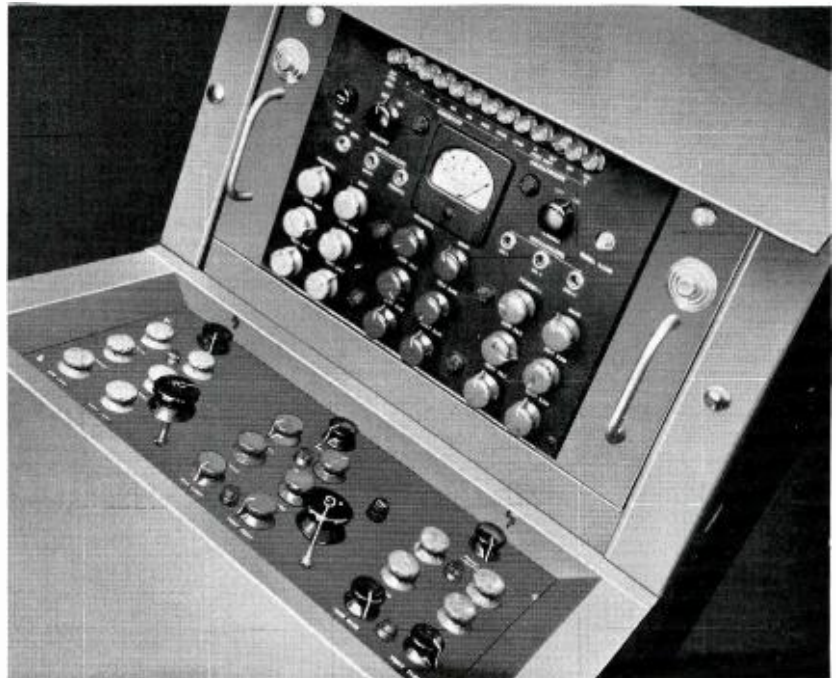

FIG. 12. Camera control panel.

3. Adjust the remote electrical focus controls for optimum as before to obtain best detail rendition and recoup rotational registry.
  4. Green centering was established so only the controls for red and blue were transferred. Simply adjust the two to match the green.
- Transfer of function is complete and all operation is then centered at the operating position. Master size controls are available for convenience in checking scan extremities.
- This remote control panel is fitted with a cover for all of the controls with only gain and pedestal protruding for operation. This is done so that the setup controls are convenient but protected against accidental brushing to mar operation. Labeling on the lucite panel is illuminated for easy

FIG. 13. Processing amplifier (above) showing camera control panel in place (below).





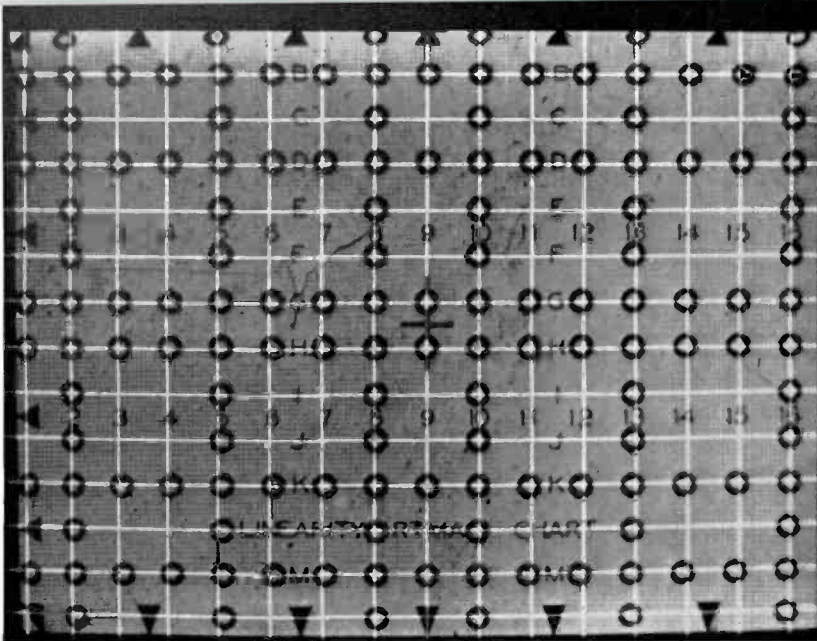
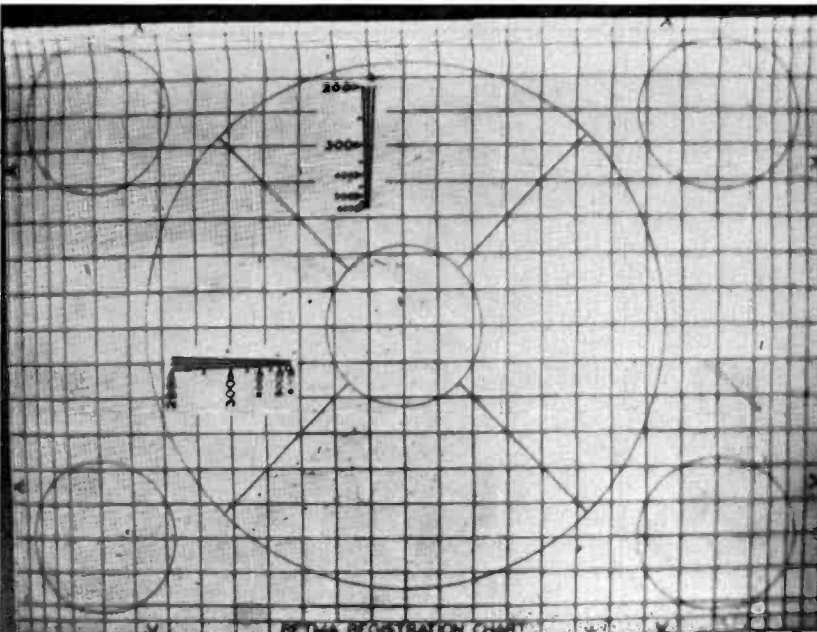
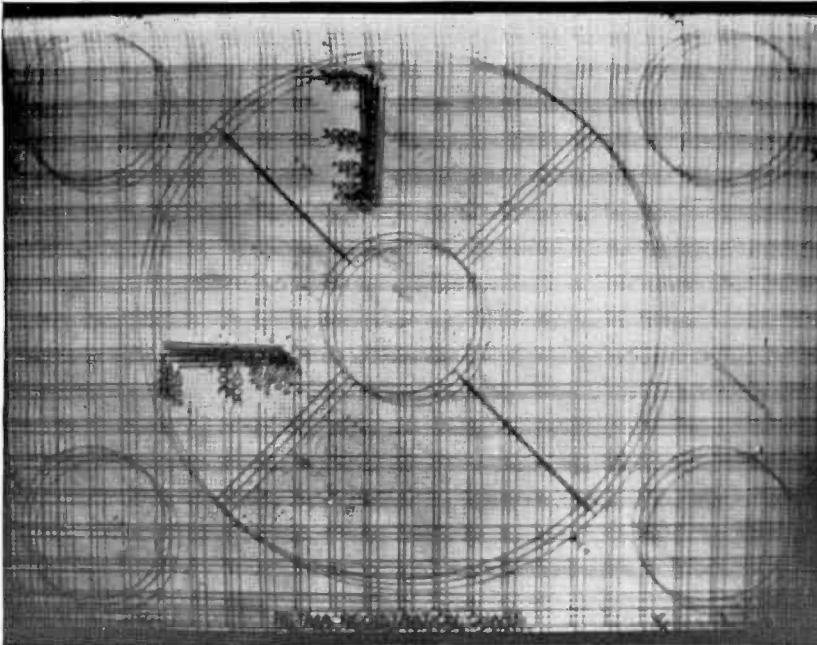

FIG. 14. Performance of system shows that linearity is better than 1 per cent in both directions.



identification. Plug receptacles in the rear of this panel receive the remote control cable from the camera, light control cable for gain adjustment from the projectors, power cable for the processing amplifier and master monitor from the power supply location and a-c line, tally voltage cable from the switcher, and the interconnection cable to the processing unit.

#### Processing Amplifier (Fig. 13)

Since this unit will be the subject of another article in the very near future, only its pertinent features peculiarly involved with the 3-V operation will be briefly mentioned. The unit is quite compact and ingeniously versatile. The front panel is hinged and four identical subchassis amplifiers plug in from the rear which in turn have receptacles for plug-in gamma corrector units for ease of servicing. Common functions are performed in the main chassis with individual operations being performed in the separate plug-in units. Three of the subchassis act on the red, blue, and green video signals while the fourth operates on the time-sequenced TM-6C master monitor CRO display signal. Gamma correction of 0.7 is customarily applied in the individual channels but of course not again in the CRO channel; hence the need for a unity gamma plug-in for it.

Kinescope and CRO signals are selected by front-panel push buttons. The kinescope can be switched to monitor red, blue, green, or combination outputs as well as the colorplexed signal for optimum setup and evaluation. The CRO display is arranged to show red, blue, and green input and output video signals in left-to-right display at horizontal or vertical rates with provision for superimposing them for accurate individual pedestal and gain adjustments. When the auxiliary calibration pulse generator which is recommended with this equipment is applied as a processing amplifier input, a unique system of level setting and level monitoring is provided. Briefly, this station or studio master calibration pulse is readily compared with an internally regenerated pulse which is then added to the CRO signal to provide a continuous peak level indication for accurate level setting free from graticules or CRO gain considerations.

FIG. 15 (center). This shows the images deliberately separated, since registration is more critically evaluated by this method.

FIG. 16. Effect of recentering the images.

The performance of the system is shown in Figs. 14 to 18 inclusive. It can readily be seen in Fig. 14 that linearity is better than 1 per cent in both directions. In Fig. 15 the images were deliberately separated since registration is more critically evaluated by this method. Recentering the images gives the picture shown in Fig. 16. Replacing this chart with a resolution chart gives the result shown in Fig. 17. These photographs were taken with equal amounts of the primaries which is a more severe test than that prevailing in operation. The resultant colorplexed and aperture corrected picture going to the switcher is shown in Fig. 18.

### Monochrome Operation

Operation of this equipment as described with the simple substitution of black and white film instead of color film is, of course, perfectly feasible. Excellent monochrome pictures will prevail on either monochrome or color sets. As has been mentioned, reproduction of the color transmission on monochrome receivers is likewise in no way degraded.

However, in view of economics and a gradual transition to color operation, it is desirable to mention that this equipment is readily adapted to strictly monochrome, only occasional color, or only occasional monochrome operation.<sup>4</sup> The equipment is available in the form of a stripped-down 3-V with only those parts essential to strictly monochrome operation with a considerable saving on initial outlay. Additional items for color operation may be obtained at a later time.

Other easily applied arrangements are available for using the entire package for monochrome. The method shown in Fig. 19 frees the colorplexer entirely, for example, for local color bar operation during a monochrome operating period. This is accomplished by merely shunting any one of the primary camera outputs through an extra aperture compensation unit on its way to the colorplexer camera input. This, with a delay cable to match inherent colorplexer delay and a TA-3A distribution amplifier can make available at the switcher an excellent monochrome signal. Simple patching will permit rotation of vidicon camera subchassis for equalizing vidicon usage. If the green channel is patched in this manner, an excellent black and white picture is available from color film either as a deliberate or emergency measure.

The other method, which has been used successfully involves relay or manual switching of circuitry in the colorplexer to

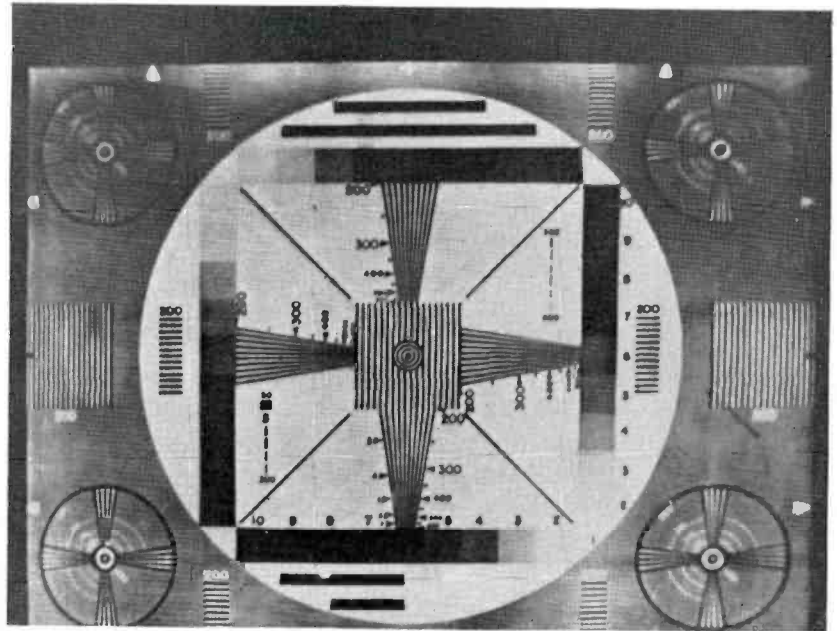

FIG. 17. Results of replacing Fig. 16 with a resolution chart.

remove burst and chrominance information during a monochrome period of operation. Obviously, these arrangements are not all that are possible, but give an idea of the flexibility possible during any sort of interim period operation. Detailed information is available on these variations.

### Picture Sources

The light that enters the camera is split into three paths and, by the use of appropriate filters is broken down into the three primary color components, red, blue and green. The use of these filters, which are necessary for good color separation, causes

FIG. 18. Resultant colorplexed and aperture-corrected picture going to switcher.

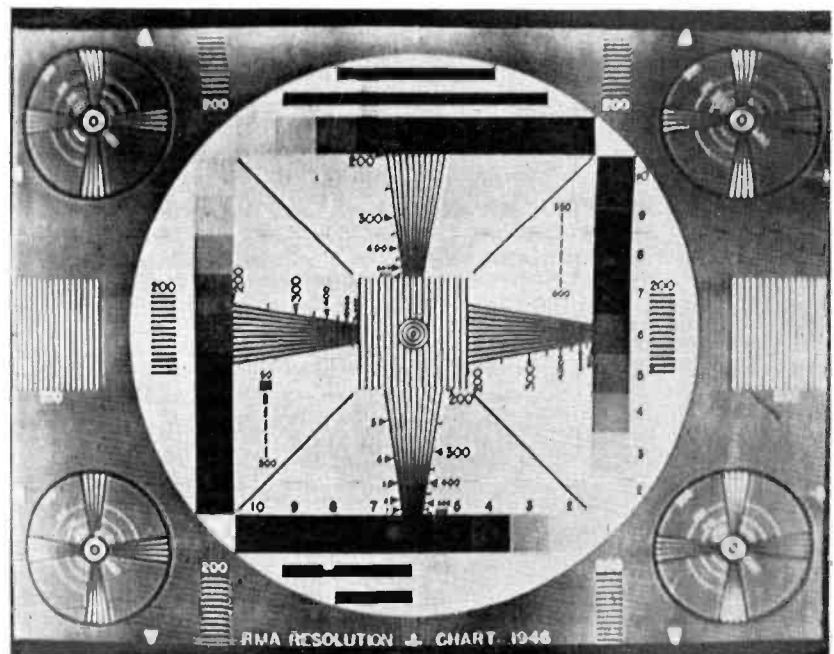



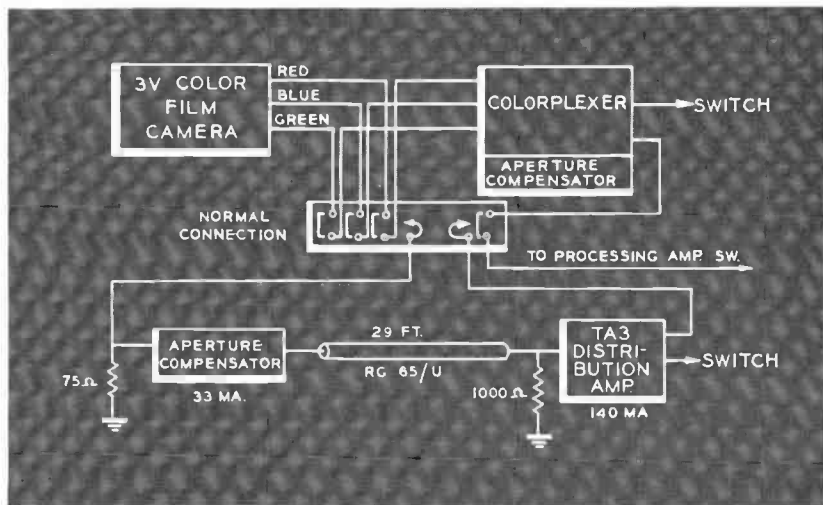

FIG. 19. How to use the 3-V system for monochrome operation.

a loss of light. Therefore, to obtain adequate signal-to-noise ratio in any color system a long exposure time of the film is required. In parallel with the development of the three-vidicon system, 16mm and 35mm projectors were designed to give long exposure of the film.

The 3-V system has been designed to handle a combination of three projectors when the TP-12 multiplexer is used as shown in Fig. 20, and four inputs when

used with the TP-15 multiplexer as shown in Fig. 21. The standard complement of projectors is usually two 16mm projectors (TP-6BC) and a slide projector (TP-3C). A 35mm projector (TP-35CC) is available and may be multiplexed into the system with any of above-mentioned projectors.

#### TP-6BC 16mm Projector (Fig. 22)

This projector is a high quality professional projector which was designed ex-

FIG. 20. Complete 3-V film system employing TP-12 multiplexer.

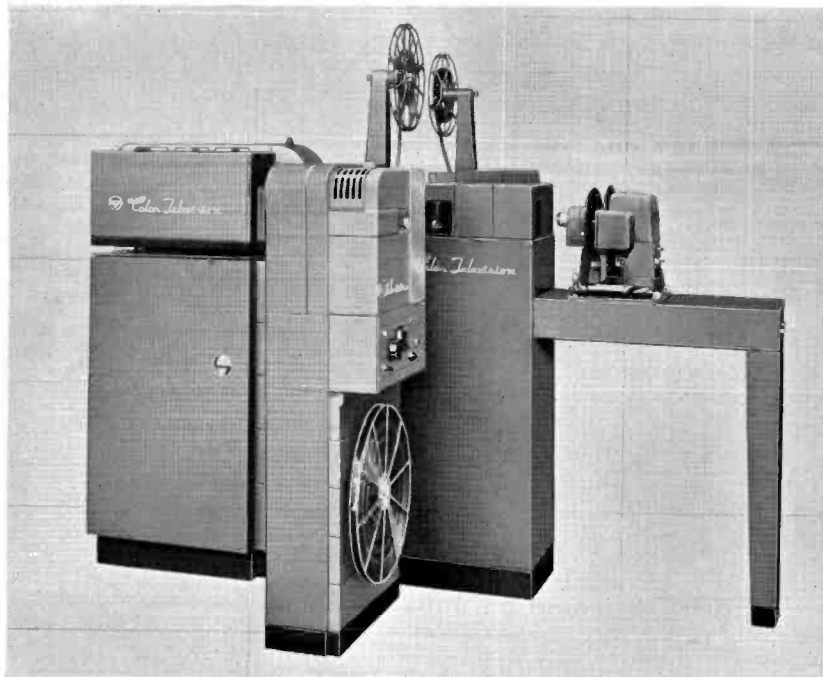

clusively for TV use.<sup>5</sup> This projector is designed to convert the standard 24 frame film rate to a 30 frame rate as required for the TV system. This is accomplished by using an unequally spaced pulldown (movement of film from one frame to next) whose ratio is 2-3 allowing the film to be shown twice in one frame and three times during the next frame. This technique permits scanning four film frames ten times to obtain five interlaced TV frames, thereby converting the 24 frames to 30 frames for TV.

Non-synchronous operation of the TV system is required in color since the color signal frequency is controlled by the crystal setting of the sync generator.<sup>6</sup> It has been determined that if the light application is at least 30 per cent of the total time, the vidicon can be operated non-synchronously. The time cycle diagram (Fig. 23) shows how this is accomplished in the TP-6 projector using an unequally spaced pulldown. The motion of the film (pulldown) is covered by the shutter which operates at 60 cycles per second. The 2-3 intermittent of the TP-6 allows the use of 30 per cent application time (or greater) and adequately meets the non-synchronous requirements of the system.

This projector uses the claw type of intermittent. This intermittent was selected after extensive investigation by RCA because of the basic advantages in film steadiness (less than 0.1 per cent of picture width) and the ability to remake a lost loop, caused by damaged film, by simply pulling the film back to its original position while the projector is in operation. The claw is equipped with three teeth for uninterrupted passage of film with several damaged sprocket holes. The upper tooth is lined with sapphire for long life. This intermittent has been designed to handle film with shrinkage of as much as 1 per cent.

This projector will handle reels of film up to 4000 feet capacity and maintain a film tension at the take up reel of 5 to 10 ounces at all times. This is accomplished by the use of a weight compensated clutch mechanism in the "take-up" assembly.

The sound pick-up system is of high broadcast quality. This system is provided with three high frequency cut off points: 5000, 7000 and 10,000 cycles per second to effectively handle film with either poor or excellent sound. The signal-to-noise ratio is 60 db at the 7 kc position while the over-all system noise level is 53 db down from program level. The entire sound pick-up system is isolated from the main frame by suitable shock mounting. This bracket

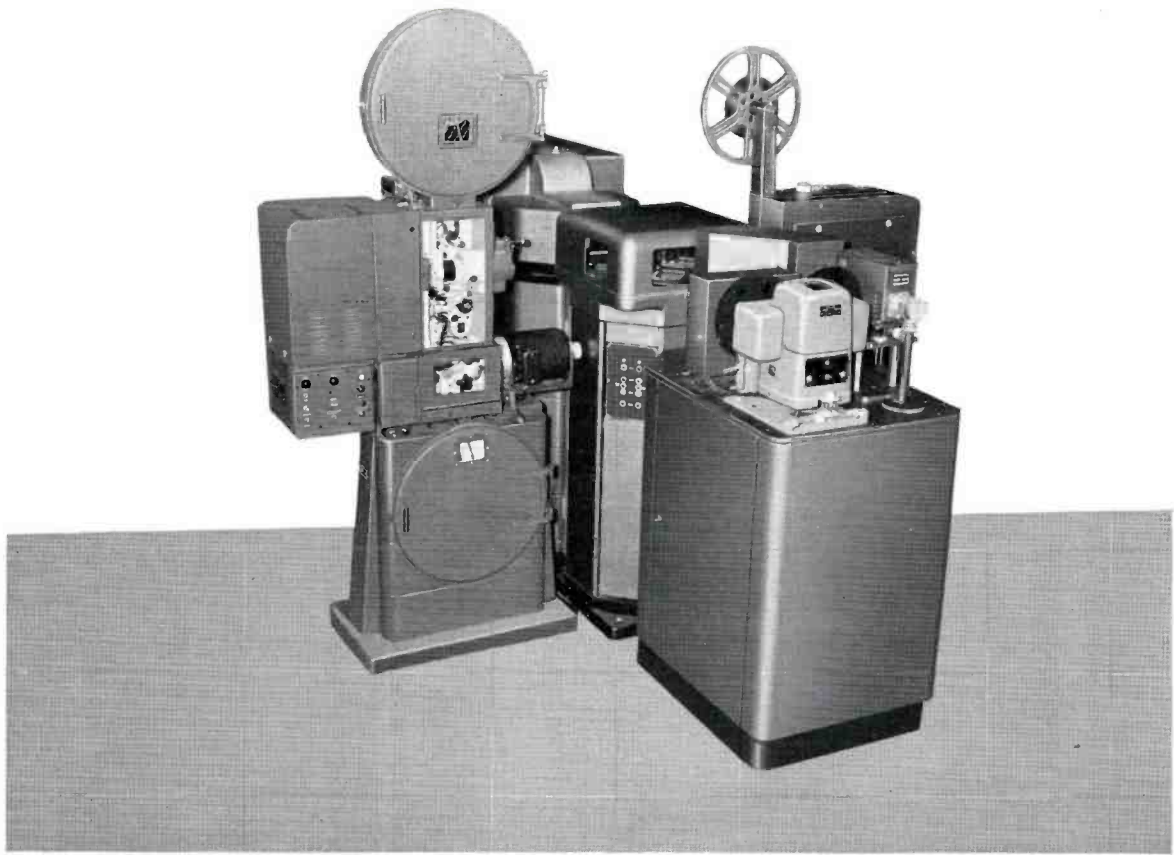
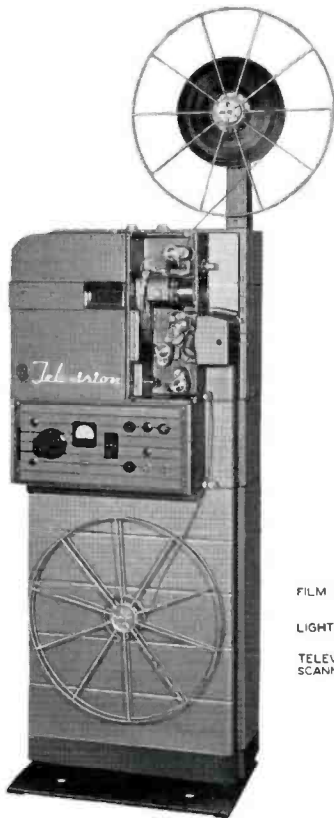

FIG. 21. Complete 3-V color film system using TP-15 multiplexer with newly designed TP-35CC 35mm Film Projector, TP-6BC 16mm Projector and TP-3C 35mm Slide Projector.



◀ FIG. 22. TP-6BC 16mm TV Motion Picture Projector.

contains two exciter lamps mounted in such a manner that if one of the lamps fails, an immediate manual changeover may be made by simply flicking a lever.

All parts of the optical system are conveniently located and removable for cleaning and servicing. One of the major problems encountered in any station is lamp failure, especially while on the air during

a commercial. With this in mind, a completely automatic lamphouse was designed for this projector. In the event of lamp failure an automatic change is accomplished in approximately one second. This change lights up a tally notifying the operator that a change has taken place and that the burned out lamp should be replaced. This replacement may be accom-

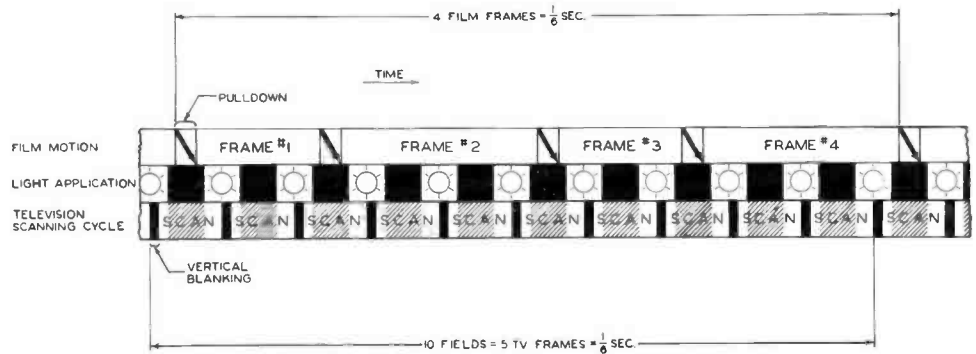

FIG. 23. Long application time cycle for non-synchronous operation of 16mm TV Motion Picture Projector.



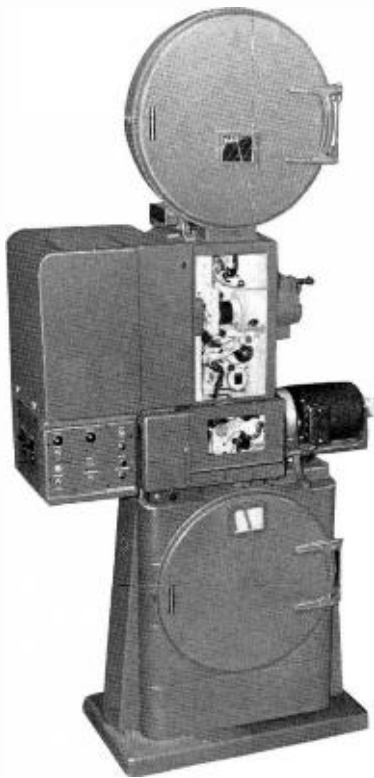

FIG. 24. New 35mm TV Motion Picture Projector. Type TP-35CC.

plished when wide application shutters are used.

The TP-6BC includes the neutral density light control unit which is described later in this article. It also contains the necessary heat absorbing and heat reflecting optics required for still operation when wide application shutters are used.

#### TP-35CC 35mm Projector (Fig. 24)

In conjunction with the development of the TP-6BC 16mm projector for color, it was necessary to develop a 35mm projector for color.<sup>7</sup> Here again it was decided to start with a tried and proved projector which had been used in TV stations for quite some time and had been very well received.

The RCA 35mm TV projector is in many respects similar to the RCA theatre projectors. The 35mm projector that has been used for monochrome utilizes a 2-3 intermittent with a pulsed light (gap lamp) keyed to the station drive signal system.

In developing the 3-V system it was determined that the 3-V color separation optics would be designed around incandescent light sources. This meant that another light source would be required for the 35mm

projector which was then using a gap lamp (pulsed arc lamp). With this in mind the automatic lamp house which is used in the TP-6 projector was fitted into the TP-35CC picture head. By designing a new intermittent that would give faster pull-down, it was possible to obtain an application time of 46 per cent which is ample, from shutter bar considerations, for non-synchronous vidicon operation.

The TP-35CC color projector is very similar to the TP-35C monochrome projector, but it has many additional features required for best color operation. A larger film magazine is included to handle a full half hour of film programming. (It was necessary to change the magazines because of increase in thickness of color film, 0.007 inch, as compared to 0.006 inch thickness for monochrome.) It has special heat absorbing and heat reflecting optics to allow for still operation with long application shutters. This projector also has designed into it the neutral density light control unit which is described later.

#### TP-3C 2x2 Slide Projector (Fig. 25)

A necessary part of any film reproduction equipment is a slide projector. Here the station may insert its commercials, news photos and call letters with a minimum of effort.

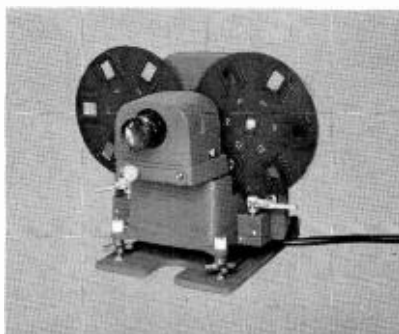

FIG. 25. Type TP-3C 35mm Slide Projector permits optical mixing to project two sources along same optical axis.

Single channel slide projectors have been in use for many years in homes and schools and were used in the early post-war years in television. With the demands for multiple commercials during station breaks it became very desirable to increase the slide handling and slide changing capacity of standard projectors. The first approach was to take two projectors placed side by side and project them on to the photosensitive surface of the tube. This method worked very satisfactorily with the iconoscope where a small amount of keystoneing

was permitted, but with the advent of the vidicon tube this was no longer possible.

In the optical system which was described earlier it became necessary to place all picture sources on the optical axis. In the case of the slide projector, it was no longer possible to place the projectors side by side. The next step was to project along the optical axis and to use a suitable optical mixing system to permit both of these pictures to be projected on the optical axis. In Fig. 25 it can readily be seen how this was done in the slide projector with a combination of front- and semi-surfaced mirrors.

This slide projector has two channels in which the slides are inserted and shown alternately. Switching between slides is done electrically, that is, by turning on one lamp and turning off the other. The slide on the darkened side is then advanced one position. This projector is a semi-automatic unit. When the slide change button is depressed the channel is switched as described above and a solenoid is energized removing a lock which allows the stall-type motor to advance the slide one position. Transition between slides is accomplished in approximately a quarter of a second, however, the entire cycle requires something on the order of one second. The unit is equipped with slide holding discs. These discs will hold six slides each, giving a total capacity of twelve slides. A spare set of discs is supplied with each unit. These may be pre-loaded and inserted in the unit very quickly while on the air.

#### TP-12 Multiplexer (Fig. 26)

This device permits mixing two or more projected images so that all are on the same optical path.



FIG. 26. Type TP-12 Multiplexer for mixing several projected images so that all are in the same optical path.

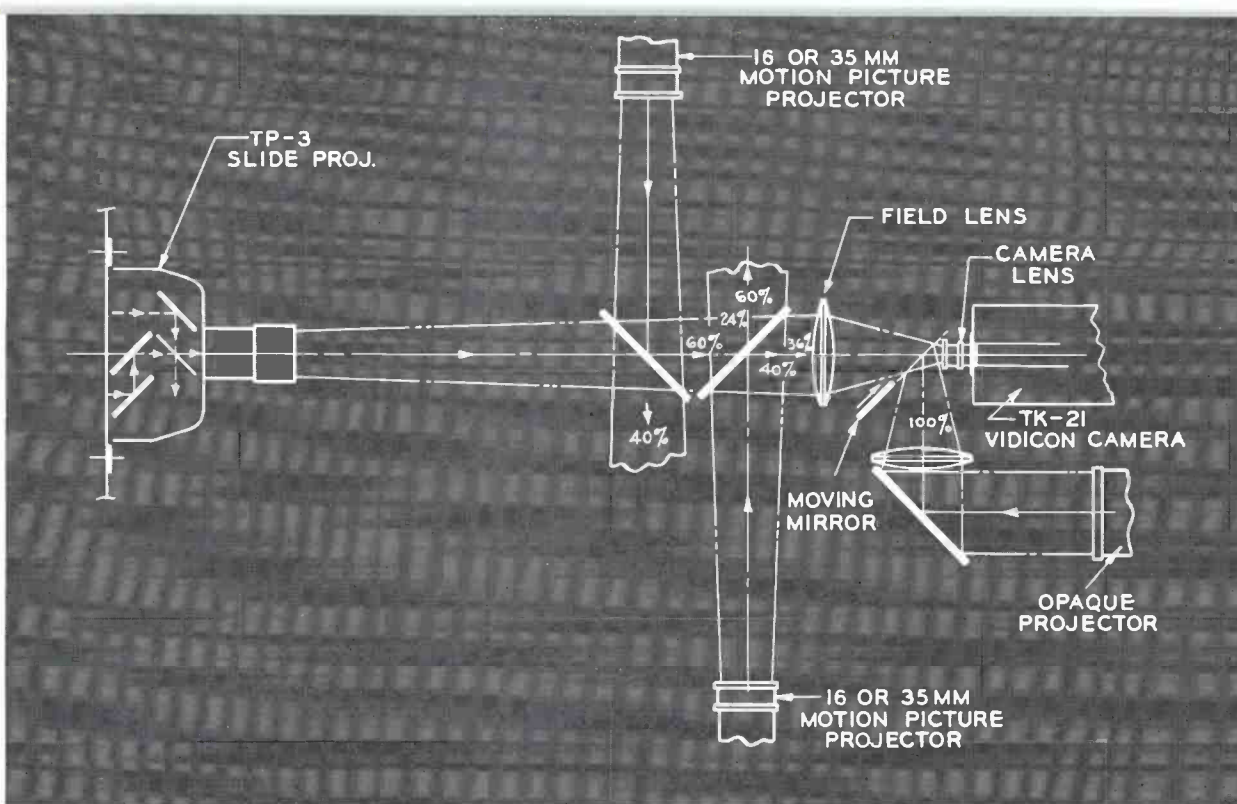

FIG. 27. Simplest but inefficient method of multiplexing (series of semi-reflecting, semi-transmitting surfaces to do optical mixing).

The simplest method would have been a series of semi-reflecting, semi-transmitting surfaces to do the optical mixing. As seen in Fig. 27 this system is very inefficient in light output. This system has been used successfully in monochrome equipment; however, because of the higher light requirements of the 3-V system, a more efficient system was developed.

The TP-12 multiplexer uses all front-surfaced mirrors and has a light output of essentially 100 per cent. These mirrors are pivoted at their base and are swung out of position mechanically in about 1/5 of a second when a change between picture sources is desired.

Several methods of moving the mirrors were investigated before the final method was adopted. This system uses a type of Geneva mechanism to rotate the mirror approximately 90 degrees from a flat position to the upright operating position. Accurate indexing here is performed by holding the mirror against an adjustable stop with a spring. Fig. 28 shows the mirror arrangement.

In this system the total transition time between picture sources is 1/5 of a second; however, it has been found in practice that the image is wiped off the field lens in about 10 degrees of travel on the incoming mirror. This means that with this system a fade to black takes 1/45 of a second, and after a short interval, the new picture

“fades in”, in 1/45 of a second. This action has obtained such acceptance in actual use that some stations have removed the doublers normally supplied with all projectors.

Another important function of the TP-12 multiplexer is the switching function it performs. The unit is designed to work with

a standard projector control panel which provides for starting and stopping of projectors, and the changing of slides. In addition, the multiplexer also performs the function of light intensity control switching so that only one projector at a time is governed by the gain control knob at the

FIG. 28. Mirror arrangement of TP-12 multiplexer showing Geneva mechanism used to rotate front-surfaced mirrors (top view).

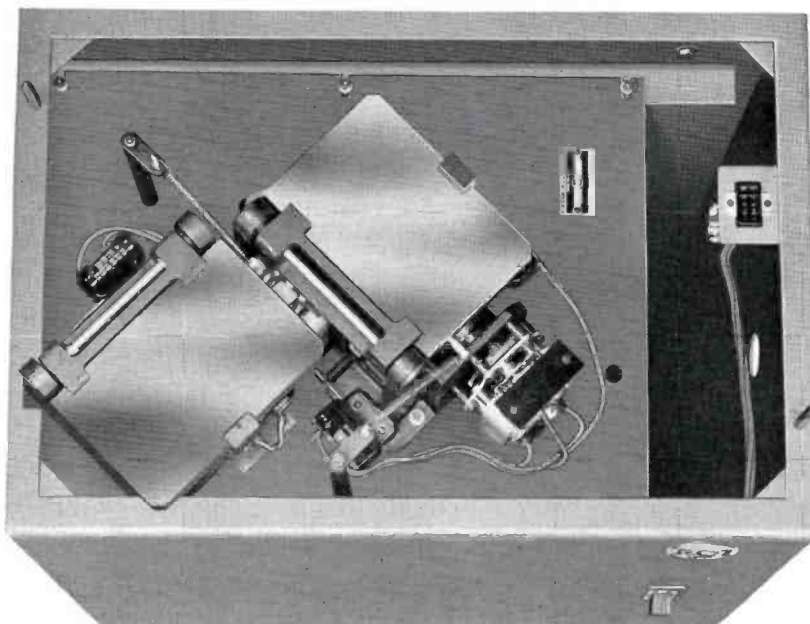



camera control position. The light controls on all other projectors are shorted to one end of the range putting the filter wedges at maximum density. This is done so that in switching between projectors the filter wedge moves up from minimum light output to the control knob setting.

### TP-15 Multiplexer (Fig. 29)

To increase the flexibility of the film system a unit that would handle more picture inputs than previously described multiplexers has been designed. The TP-15 includes a main pedestal which contains the mirror mechanism, a pedestal to mount a 1-V camera and a slide projector, and a 1-V camera optical assembly. The principal feature of the TP-15 is provision for projecting pictures into two television film cameras at the same time. Normally, these are the TK-21A monochrome camera and the TK-26A color 3-V camera, though other combinations may also be used. Four movable mirrors are used to permit selection of combinations of inputs and outputs. Fig. 30 shows the arrangement whereby four inputs can be switched to any of two outputs. Some of the possible combinations are as follows:

1. Multiplex 2 motion picture projectors, 2 slide projectors, a 3-V camera and a 1-V camera.
2. Multiplex 2 motion picture projectors, 2 slide projectors and 2 3-V film cameras. (The second 3-V camera is mounted in the normal position for the 1-V camera and slide projector pedestal.)
3. Multiplex 2 motion picture projectors, 2 slide projectors and 2 1-V camera chains. (The second 1-V camera and slide projector are mounted on their pedestal in the normal 3-V camera position.)

The unit may be operated from a local or remote control panel or both. This control panel is equipped to start, stop or still-project any of the projectors and to operate the slide projectors. Dual channel controls are provided to enable the operator to select any of the picture sources for either of the camera positions (Fig. 31).

For ease in assembly and service the control panel and all the associated control circuits are mounted on a vertical chassis which is supported by a pair of drawer slides to permit withdrawing the entire chassis without disturbing the remainder of the system.

The operation of the TP-15 multiplexer is very similar to the TP-12 multiplexer.

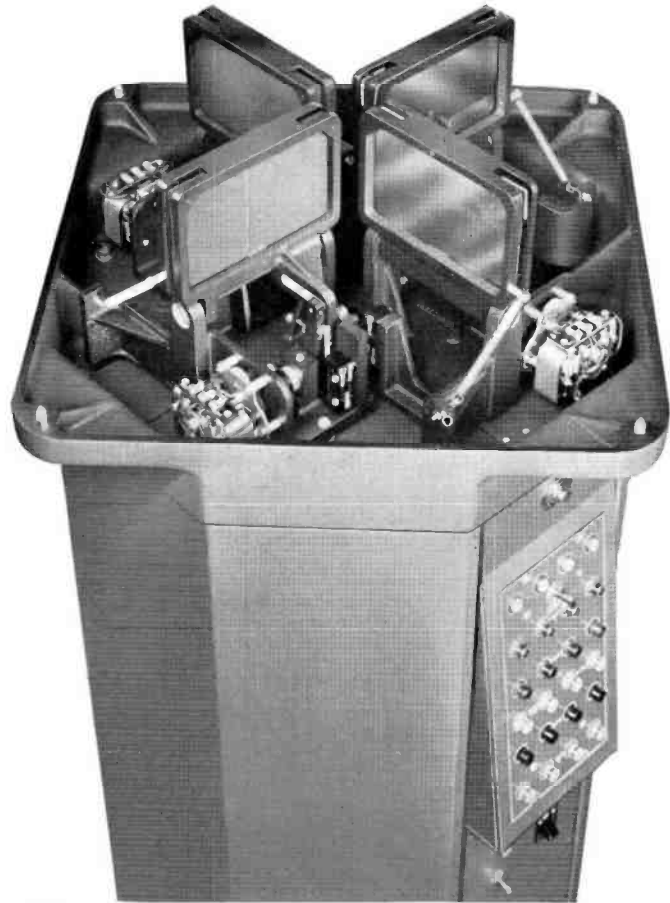

FIG. 29. Type TP-15 Multiplexer with four optical inputs and two outputs.

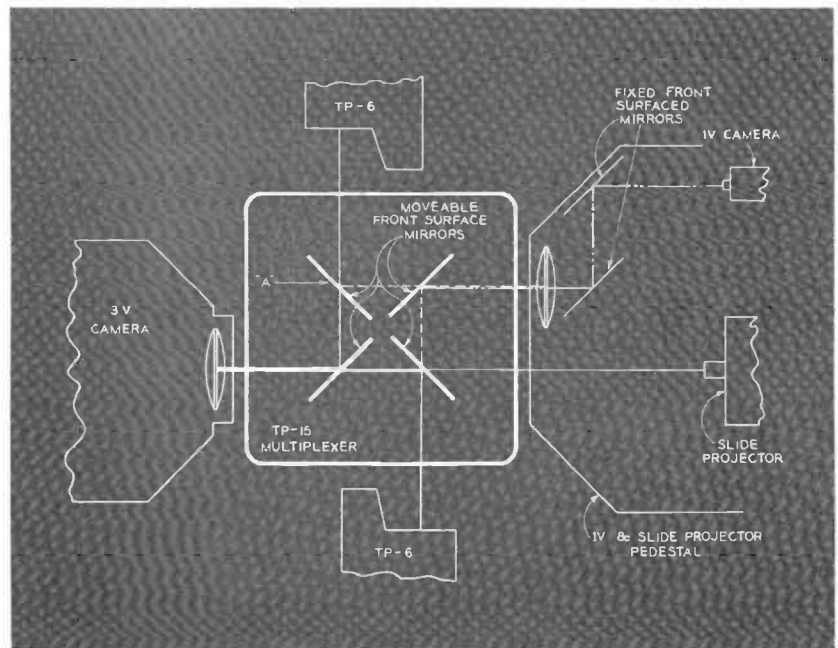

FIG. 30. Shows arrangements whereby four inputs can be switched to any of two outputs. ("A" indicates position of fourth projector, which is placed on the cover of the multiplexer, and is optically connected to the multiplexer by a periscope accessory.)

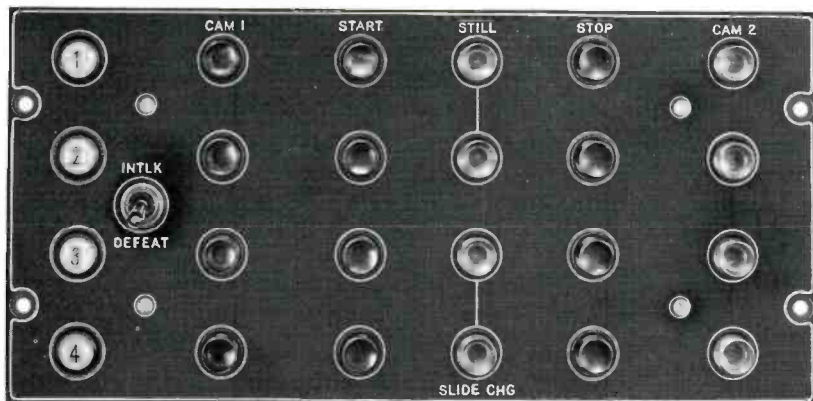

FIG. 31. Control panel for TP-15 Multiplexer can be used at local or remote position.

It includes all of the functions performed by the TP-12 as well as its own obvious advantages.

#### Light Intensity Control<sup>8</sup> (Fig. 32)

To obtain the best results from the 3-V system a new method of gain control has been developed. This system controls the light output at its source rather than varying the video gain in an amplifier. This method permits the handling of film with density variations from 100 to 1 without affecting the signal-to-noise ratio of the system.

The device uses a continuously variable neutral density wedge. The wedge is circular in shape and is approximately 6 inches in diameter. For minimum shading effect due to the gradient of the wedge it is placed in the vicinity of the crossover point of the condenser lens systems. The density of the filter varies continuously from about 0, or essentially 100 per cent transmission, to 2, or 1 per cent transmission, with a gradient of 0.006 density unit per degree of angular rotation.

Because of the presence of highly concentrated infra-red rays in the condenser system it is necessary to filter these rays out of the system before they strike the gelatin material of the wedge. Serious damage to the wedge in a very short time would otherwise result. To accomplish this, an infra-red reflecting dichroic and a piece of heat absorbing glass are used to reduce the infra-red rays to a point where they do not affect the wedge.

The wedge is driven by a servo mechanism mounted in the projector. Fig. 33 shows the system as used in the RCA TP-6 and TP-35 projectors.

#### Conclusion

The inescapable conclusion of this investigation was that a system employing three vidicons together with intermittent

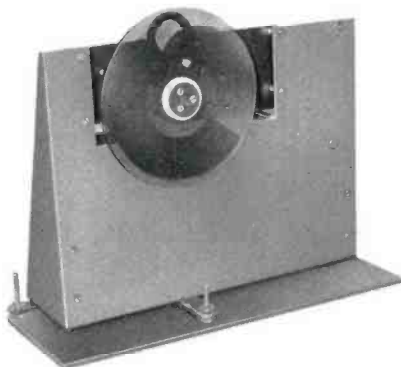
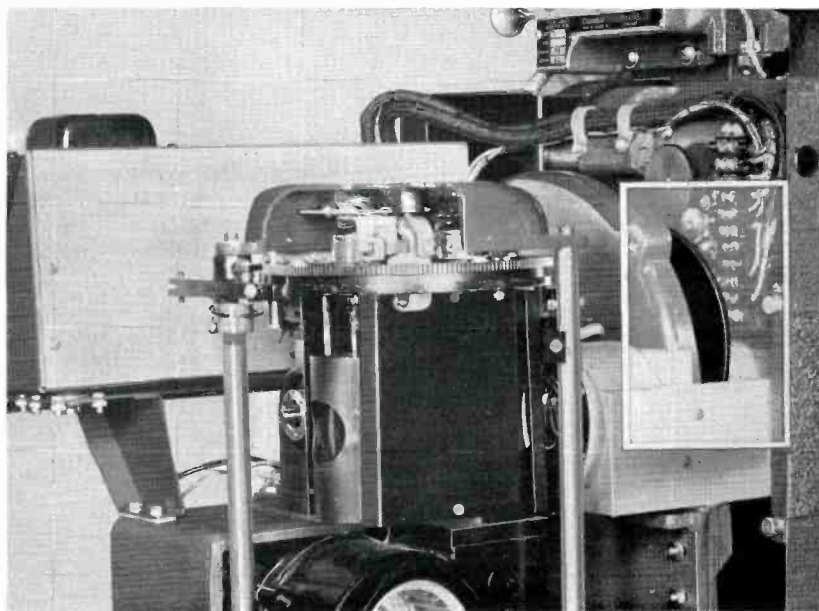

FIG. 32. Neutral density filter method of light intensity control for 3-V film system.

FIG. 33. Light intensity control installed in RCA TV motion picture film projector.



projectors offered the most practical approach to a system for high quality color film pickup and reproduction. A subsequent program for designing equipment has produced a complete, integrated package including camera, projectors, and multiplexers, and the necessary control features. At the time of this writing, a substantial number of these equipments are in successful operation in broadcast stations all over the country.

#### Bibliography

- <sup>1</sup> Article by W. J. Poch, BROADCAST NEWS, No. 77, Jan.-Feb. 1954, "Film Equipment for Color TV Applications".
- <sup>2</sup> Article by W. R. Isom, Journal of the SMPTE, Vol. 62, January 1954, "Fast-Cycling Intermittent for 16mm Film".
- <sup>3</sup> Article by W. L. Hurford-R. J. Marian, RCA REVIEW, Volume XV, No. 3, September 1954, "Monochrome Vidicon Film Camera".
- <sup>4</sup> Paper presented by A. H. Lind, L. E. Anderson, N. J. Oman, at NARTB Convention, May 26, 1955, "The Integration of Color Equipment".
- <sup>5</sup> Article by H. G. Wright, BROADCAST NEWS, No. 74, May-June 1954, "The TP-6A".
- <sup>6</sup> Non-synchronous operation of the TV system is required. The color signal frequency is controlled by a crystal in the sync generator to maintain the color subcarrier frequency within permissible limits.
- <sup>7</sup> Paper presented by W. F. Fisher and W. R. Isom, SMPTE, Semi-Annual Convention, Chicago, Illinois, April 18-22, 1955, "35mm Intermittent Motion Picture Projector for Color Television".
- <sup>8</sup> Paper presented by K. Sadashige and B. F. Melchioni at SMPTE Semi-Annual Convention, April 18-22, 1955, Chicago, Illinois, "Control of Light Intensity in Television Projectors".



# SOME NOTES ON INTEGRATION OF COLOR EQUIPMENT AND EXISTING MONOCHROME FACILITIES

**EDITOR'S NOTE:** This article is adapted from a paper by A. H. Lind, L. E. Anderson and N. J. Oman of Studio and Transmitter engineering sections, Engineering Products Division. The paper was delivered by Mr. Lind at the Engineering Session of the 33rd NARTB Convention in Washington, D. C. The following article discusses new equipments and latest techniques which apply to integrating color and monochrome equipment in the television plant.

The task of building and facilitating a television broadcast plant is necessarily a complex one. Any attempt to cover this broad technical field in a short discussion would be very sketchy. Detailed analysis of the equipment requirements for both monochrome and color television facilities along with suggested approaches to the equipment planning have appeared at various times in *BROADCAST NEWS*. In issue No. 77, January-February 1954, L. E. Anderson's paper, "How to Plan for Color" and N. J. Oman's paper, "Television Transmitter Operation with Color Signals", are published. Issue 82, February 1955, contains Mr. Anderson's paper, "Color Equipment Planning."

The requirements for broadcasting color TV tend to fall into three distinct categories. The logical first category covers the equipments needed to broadcast a network originated color signal locally. Modifications and/or adjustments to the transmitter are included here. The second category covers the equipment needed to originate color film programs. The third category covers the equipment needed to originate live pick-up color programs. In the articles by Mr. Anderson and Mr. Oman there are detailed block diagrams and tabulations of the equipments required for each of these categories. This wealth of information can best be assimilated by studying their papers.

Rather than attempting to summarize this already published information which covers these areas of color equipment requirements, this paper describes several techniques and new equipment, now available, that can extend the usefulness of existing monochrome and color TV equipment. Thus, broadcasters may achieve even greater usefulness from equipment they now have.

## Signal Delay in Integrated Color-Monochrome Systems

One basic question that confronts the broadcaster when he starts planning for color is, "Shall I make the color and monochrome operations separate, distinct and independent or shall I combine them?" In addition to the technical problems, consideration of commercial and programming aspects are involved. The choice in the majority of cases has been to combine the operation. Thus the equipment facilities are integrated.

The following comments are intended to point out an important problem that arises when color and monochrome equipments are integrated into a common system. While not of major concern to the local broadcaster who carries only network color signals it becomes important immediately upon the decision to equip the station to originate color signals.

The delays encountered in transmitting TV signals around a broadcast plant have raised problems in monochrome installations. Since it is established practice to mix the synchronizing signal at the point of final switching control, this signal remains constant in timing as switching from one picture source to another occurs. However, the path lengths of the pulse signals from

the synchronizing signal generator to the cameras and the picture signals from the cameras to the final point of switching may differ appreciably from the path length of the synchronizing signal from the synchronizing signal generator to the point of sync mixing. In addition there may be further differences in the paths of different camera chains. If left uncompensated, the picture information from the various sources, when viewed on a home receiver, will be located in different horizontal positions since the edge of blanking shifts in timing with respect to the sync signal. This is due to these differences in delays. Small displacements that correspond to timing errors of the order of 0.25 microseconds are usually acceptable. Timing differences of a magnitude requiring compensation can be equalized by introducing suitable additional delay in either the pulse lines to camera equipment or in the picture signal lines after the cameras. The pulse delay approach has proved to be less critical and most practical. If video delay lines are used, they have to be wideband types with well behaved phase and amplitude characteristics. The object, of course, is to introduce sufficient delay in all lines except the one having the greatest delay. Thus the total delay in each signal path is equal to the delay of the longest path in the un-

FIG. 1. Typical integrated color-monochrome TV system.

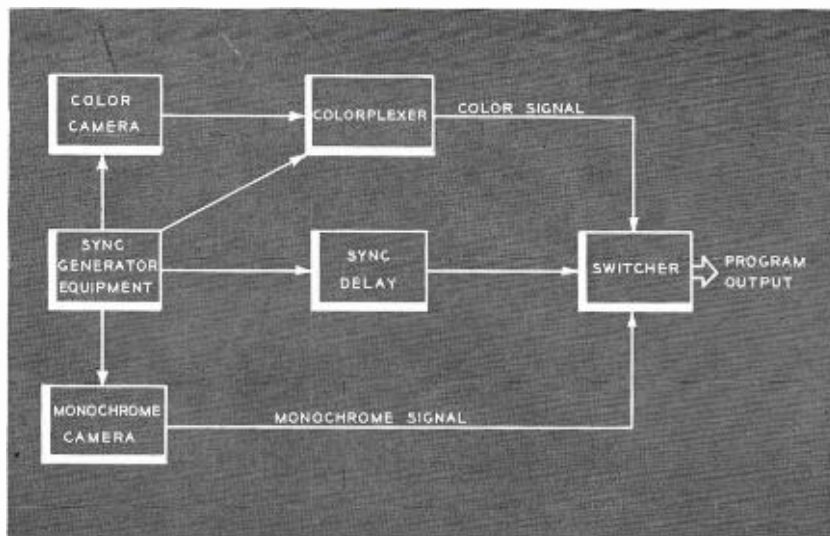

compensated system. Appropriate delay must be introduced in the sync signal line as well.

When an integrated color and monochrome system is introduced, such as that shown in Fig. 1, a new delay problem arises. In the color signal path a new element has been introduced. It is the colorplexer. The functions of the colorplexer inherently introduce an appreciable delay in the color signal. This delay is about 1.2 microseconds. This is enough to displace the color picture about 2% to the right with respect to monochrome pictures. Furthermore the disparity between the monochrome and color signals would be so great that the tolerance permitted by the FCC signal specifications in the "front porch" and "back porch" periods of the composite signal would be exceeded. Delay equalization can be realized by introducing delays in the sync generator pulses used to drive all monochrome cameras. These delays must be equal to the delay introduced by the colorplexer in the color signal channel.

At least three means of accomplishing the required pulse delays have been used successfully (see Fig. 2). First, the coax cables connecting the sync generator equipment to the monochrome cameras can be made sufficiently long to contribute the required delay. This possibility is not very attractive because cable lengths of the order of 800 feet are required. Second, should two sync generators be employed, one for color camera feed and the other for monochrome camera feed, the generator used for the monochrome cameras can be genlocked to the color generator and

phased so as to deliver its output signals with the proper delay. Unless the second sync generator is already available, or is needed in the system for other purposes, it would be difficult to justify its cost for the sole purpose of accomplishing pulse delay. Third, artificial delay lines or lumped constant delay networks can be used. This means is generally most economical and space conserving.

#### Transmitter Plant Operation With Color Signals

When a transmitter plant is to be used for the transmission of color signals, it is necessary to carefully check the performance of all equipment used in order to insure against degradation of the color signal. Test procedures and test and operating equipment design are constantly being improved to enable the transmitter staff to achieve better performance from their plant. Means for checking frequency response versus depth of modulation, differential gain and differential phase have been available for some time. It has not been practical to attempt precise delay compensation of the equipment at the transmitter because of the lack of a reliable monitoring demodulator. A further difficulty has been the lack of measuring equipment to show compliance of the signal output of such a demodulator with FCC requirements for envelope delay. The latter problem still exists and it is unlikely that an acceptable solution is imminent. However, it has been found possible to incorporate a number of changes in RCA BW-4A and BWU-4A Demodulators so that they may be used to evaluate the delay performance of a transmitter.

Test signals may be obtained from a square wave generator or other means of providing special test pulses for observing the transient response of equipment. Another test signal of value is the familiar indian-head test pattern produced by a monoscope camera. This signal may be conveniently viewed on both an oscilloscope and on a station master monitor. In making tests associated with delay compensation, it is important that observations first be made on the signal source; then progressively at the outputs of following equipments including connecting lines and switch gear until a nearly perfect transient and frequency response is obtained exclusive of the transmitter. It is well to check the transmitter for optimum performance prior to attempting delay compensation adjustments. Following these preparations it will be possible to view the performance of the transmitter and to adjust the variable sections of the delay compensating equalizers for optimum overall performance. The transmitter video frequency response as viewed at the output of the monitoring receiver should not be degraded by the receiver by more than  $\pm 6\%$  as referred to the 200 KC response, to a frequency of 4 megacycles. Measurements of delay or transient observations should be made with the sound notch of the receiver in the "out" position. The receiver output should be terminated in a 75 ohm load with a  $\pm 1\%$  tolerance. For square wave or special pulse modulation where no sync pulses are present, the transmitter should be operated in the AC or unclamped condition at approximately  $\frac{1}{2}$  power. Modulation for observation of transients should be of low level to avoid quadrature distortion which is produced by deep modulation in a single sideband system and cannot be equalized by the corrective networks in the video circuits.

FIG. 2. Delay equalization in color-monochrome system.

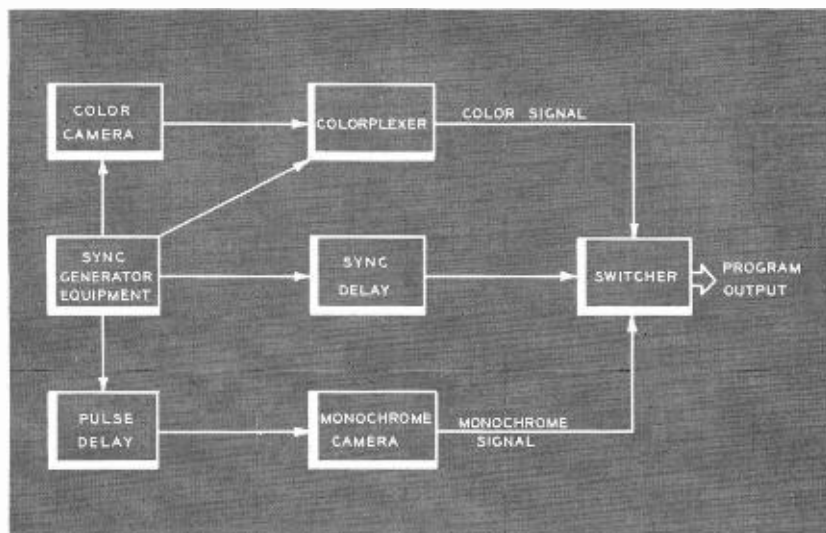

As a means of obtaining a reference for the best possible output wave shape that might be obtained through the complete system, it is suggested that 100 KC square wave test signal be viewed after being passed through the 4.2 MC compensated low pass filter only, which is part of the video input gear.

Fig. 3 shows oscilloscope waveform pictures of the output signal when a 100 KC square wave is used as the input signal to a 4.2 MC compensated filter. Bear in mind that the filter should be driven by a 75 ohm source and should work into a 75 ohm load  $\pm 1\%$ .

In viewing a test pattern on a monitor kinescope display, the transients will be most visible if the contrast is set maximum



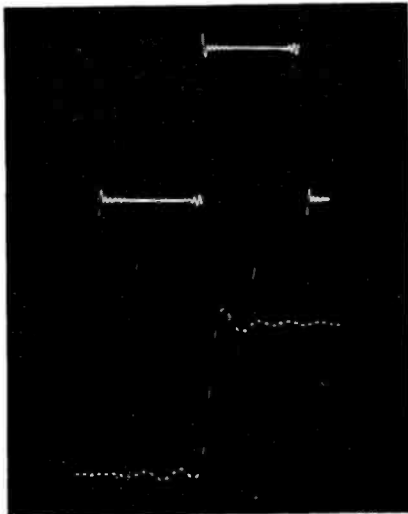

FIG. 3. Photo of 100 kc square wave signal passed through a 4.2 mc low pass filter (top); with 0.5  $\mu$ sec marker (bottom).

and brightness reduced. If the test pattern is left on the monitor too long, it may be visible for a relatively long period because of the residual persistence of the kinescope phosphors. Unless care is taken, such a long persistence image might be mistaken for a reflection.

The comments which have been made concerning the checking of transient performance of transmitting equipment are not complete, but are offered as an aid in setting out to make such test.

To obtain optimum performance from a revised BW-4 Demodulator the modifications required should be done at the RCA Camden Plant. The following series of

pictures illustrate performance characteristics of the modified demodulator.

Fig. 4 shows the 100 KC square wave response of the BW-4 with the 4.2 MC low pass filter in the transmitter. Fig. 5 shows the IF response of the BW-4. The overall amplitude vs. frequency response without the 4.2 MC filter in the transmitter is illustrated in Fig. 6. Fig. 7 illustrates the overall envelope delay of the demodulator.

The rebuilt demodulator will be trustworthy for delay measurements and should be a much better monitoring demodulator than has heretofore been available. With the sound notch "in", as for driving a color monitor, the frequency response will be down about 1.5 db at 4.0 MC. Linearity as checked with a calibrated 6 db pad at the radio frequency should be within 2%. The BW-4 is not recommended for making differential phase tests. A test of this characteristic can be made using a diode demodulator.

#### The TP-15 Multiplexer

The RCA TP-15 is a new multiplexer designed for use with 3-V Color and 1-V Monochrome film cameras, 16mm, 35mm and slide projectors in a variety of combinations for TV film pickup chains.

The diagram, Fig. 8, shows a possible arrangement of 3-V camera, 1-V camera, 2—16mm film projectors and a 2 x 2 slide projector. The light paths between the projectors and the two film cameras are indicated by the heavy lines. The solid lines follow through to the field lens of the 3-V camera and the dashed lines carry through from the mirrors to the field lens of the

1-V camera. As indicated in the diagram, the multiplexer employs movable front surface mirrors to establish the desired light paths, with only one light path between a projector and a camera being used at a time. The mirrors are mounted in a 4 mirror star array, each one being driven by a reversible motor and limited travel geneva mechanism. The principle of operation and mechanism design are basically the same as is used in the TP-12 Multiplexer which is now proved in service.

Fig. 9 shows the physical appearance of the mirror star. The appropriate mirror positioning motor is selected and energized from a control panel. The panel shown in the lower right corner of the picture is a control panel providing local control at the multiplexer. A similar control panel can be mounted in an RCA standard equipment housing console when remote control is desired. Pushbutton control for starting, stopping, still projection, and *show* on camera #1 or *show* on camera #2 is provided. The control circuits are designed to favor one camera. This camera maintains priority over the other so that the second camera cannot take the picture away from the first one while it is on the air. Either camera #1 or camera #2 can be established as the preferential one.

A little study makes apparent a number of other combinations of projectors and cameras that are possible. With the combination shown in Fig. 8 it is possible to operate both the 3-V camera and the 1-V camera simultaneously. Of course, this does not mean that both cameras can look at the same projector simultaneously, but while the 3-V camera is looking at one

FIG. 4. Oscilloscope photo of 100 kc square wave response of BW-4 Demodulator (top). Same with 0.5  $\mu$ sec marker (bottom).

FIG. 5. IF response of BW-4 Demodulator as shown on the oscilloscope with sound notch-in (top); sound notch-out (bottom).

FIG. 6. Oscilloscope photo of overall video response of BW-4 Demodulator (top); markers at 5, 4, 3, 2 and 1 mc (bottom).

FIG. 7. Envelope delay of BW-4 Demodulator with frequency markers at 1, 2, 3 and 4 mc (top); delay markers spaced at 0.1  $\mu$ sec (bottom).

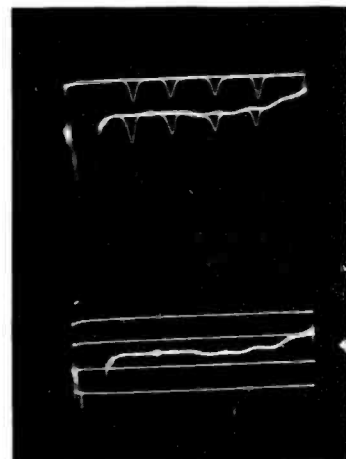
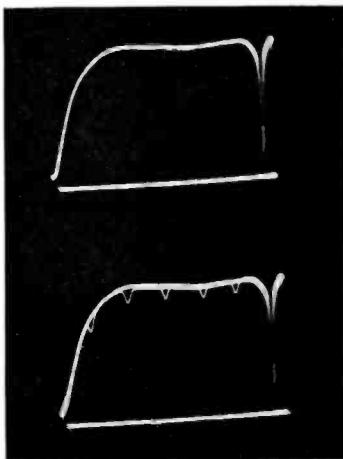
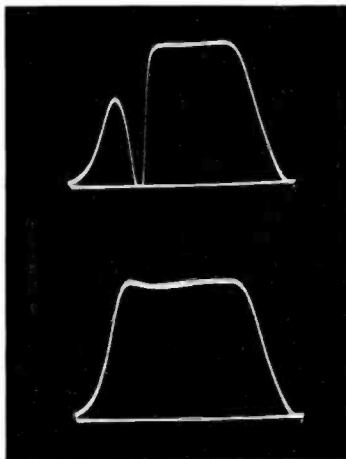
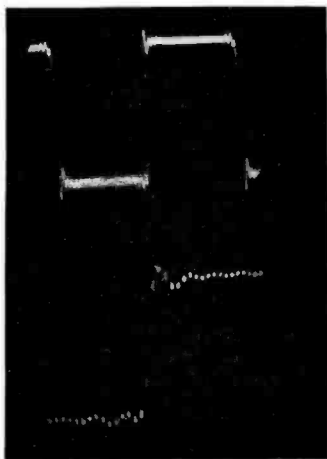

projector, the 1-V camera can look at either of the others. The converse is also true. Thus it is possible, for example, to use the 1-V camera to preview the picture from the upcoming projector while the 3-V camera is looking at a given projector and supplying the program signal. This facility for preview permits pre-setting the light intensity control for the projector next to be used as the program source so that the transition from projector to projector as viewed by the 3-V camera will not give rise to annoying disruptions or shifts in the level of the video signal at its output. Previewing for level setting requires that the cameras be adjusted to have the same sensitivity to the light input. It would, of course, be possible to originate a monochrome program signal from the 1-V camera and one projector while originating a color program signal from the 3-V camera and another projector should this be desired.

In some instances, particularly network film show originations, a protection 16mm film is run simultaneously with the primary program 35mm film. The protection print is usually monochrome for economic reasons. If a TP-15 multiplexer is set up with a 3-V camera, a 1-V camera, a 35mm projector and a 16mm projector, a system providing double protection results. Normally the 3-V camera would be looking at the 35mm projector and be providing the program signal. The 1-V camera would be looking at the 16mm projector and providing the protection signal. If the 3-V camera should fail, the 1-V camera could operate from either the 16mm or the 35mm projector for a higher quality picture. This system would accommodate the failure of either camera and either projector without the loss of a usable signal.

From the foregoing brief comments it should now be apparent that anyone considering equipping his station with a monochrome vidicon film camera chain, should seriously look at the possibility of utilizing the TP-15 as the multiplexer, along with film projectors, slide projector and 1-V camera. Also, at the same time he should plan for the additional space required to install a 3-V color film camera. Thus, when the transition to color operation is made, most of the elements are available. This possibility makes the TP-15 a very useful equipment in the planning and execution of an installation that may start as a monochrome film chain facility and later expand to a color film facility.

FIG. 9. Mirror star of the 3-V Multiplexer. Local control panel is visible in the lower right corner.

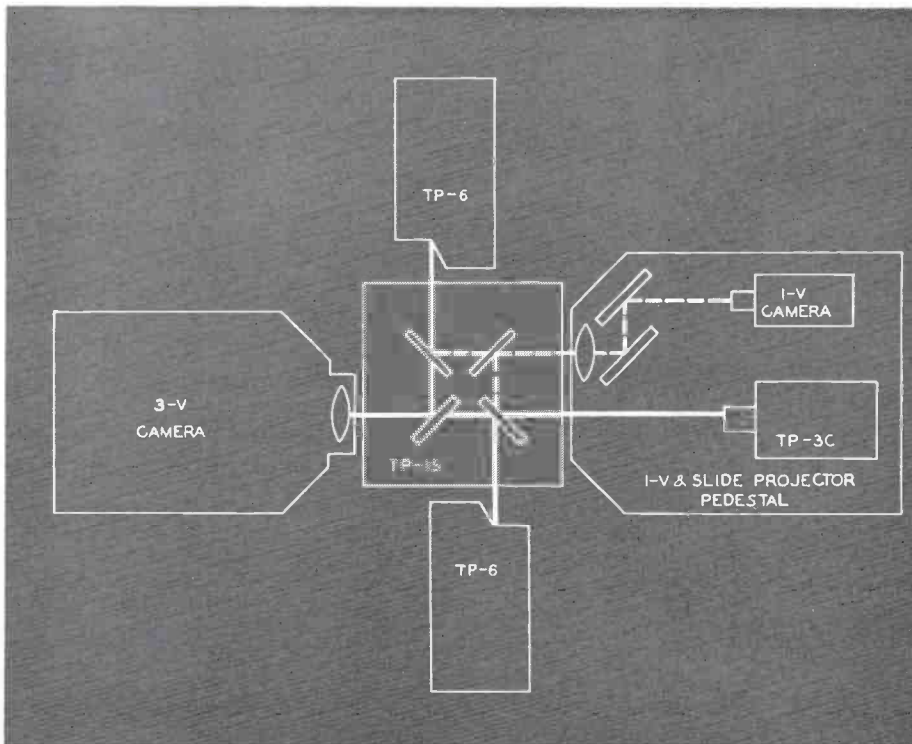

FIG. 8. Typical integrated color-monochrome film system using new TP-15 Multiplexer. Heavy lines indicate light path—solid, from picture source to 3-V camera; dotted, from mirrors to 1-V camera.







**STATION IDENTIFICATION**



**PROGRAM TITLES**



**COMMERCIALS**



# How to get from

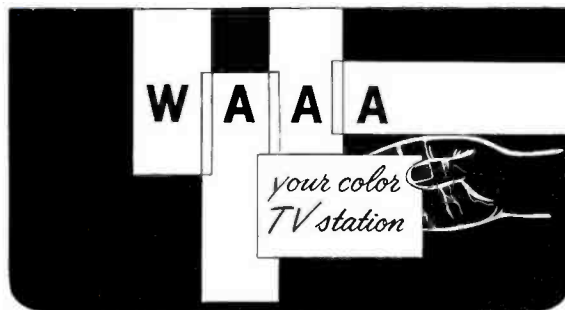
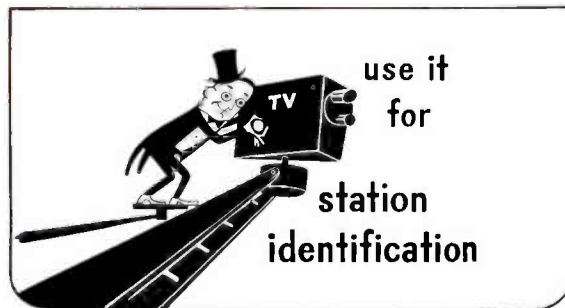

Today, with almost 200 stations equipped to transmit network color programs, station breaks in color are becoming increasingly important. Those stations which do not have either live or film color origination equipment are forced to do their station breaks in black-and-white; thus breaking continuity and distracting the color audience. In recent months, techniques have been devised whereby color effects may be produced from black-and-white slides and artwork at a modest equipment investment. The equipment necessary is made available as the RCA Color Effects package. With this equipment, station ID's program titles and commercials can now be produced with color effects as shown on this page. Only a few of the 56 possible color continuations are shown here.

#### Color Effects Techniques

Generally, color effects techniques utilize a source of monochrome camera signal (film or live) from the station's existing equipment. This video signal, in combina-

# COLOR EFFECTS

## BLACK and WHITE artwork



tion with a blanking signal is fed to two or more of the inputs of an RCA colorplexer. The result is that one color is electronically added to the black portions of the picture while another is added to the white portions. A complete technical description of these techniques appears on the following pages.

### Demonstrated at NARTB

The equipment described on these pages was first demonstrated at the recent NARTB Convention. Here a combination of show cards and an RCA Vidicon Film Camera Chain, TK-21, were used as a source of monochrome signal. The cards were mounted in an automatic changing machine to provide a steady flow of varying picture material. An assortment of six of these cards is shown here to point up varying art techniques as well as the different uses. In practice it was found that white subject material on a black background provided the best picture source since it was more easily lighted evenly and

shaded properly in the camera. Since reversing the polarity of the video signal will reverse the colors in the final picture, this white on black technique can be standardized without losing any of the possible color combinations. If the original art is prepared black-on-white, slides can be made directly from negatives or opaques from negative photostats, thereby keeping preparation costs to a minimum. The art for the NARTB demonstration was prepared directly on cards to fit the changing machine.

### Picture Sources

Any film or live picture source can be used with the Color Effects equipment. For instance it may be practicable to use an old iconoscope film chain with either a 2" x 2" slide projector or Telop as a source of slide and/or opaque material. If desired a "live" Image Orthicon camera may be used with flip cards. In the case of a vidicon camera, it may be operated "live" with show cards or normally with 2" x 2" slide projector or

Telop. It will be a small task to set up any one of these monochrome signal sources in a station for use with Color Effects when desired.

### Additional Benefits

Color Effects equipment offers benefits in addition to presenting color station ID's, program titles, and commercials. First, it will give station personnel an opportunity to work with color origination equipment and develop the good operating techniques that come with experience. In addition the equipment offers means for operational "check-out" of video distribution system. The entire television plant can be "checked-out" for color operation using the color bar pattern as a standard. System improvements required for color can be determined and made in advance of purchasing other origination equipment, live or film. All of the Color Effects equipments are required and can be used without duplication when further color equipment is purchased.



# COLOR EFFECTS

## and how it works

by

**C. R. MONRO**

TV Terminal Equipment Engineering  
Engineering Products Division

The Color Effects signal is made by exactly the same process as used for the familiar Color Bar signal. Video signals fed into various combinations of one, two, or all three of the inputs of an RCA Colorplexer will produce patterns of color in the output signal. Proper combinations of pulses from a Color Bar Generator are colorplexed to form the three primary colors and their three mixture colors. In the same way, a monochrome signal from a camera may be fed into a colorplexer to yield a result in two colors—one representing white in the picture and one representing black. An all-white signal (blanking) and an inverted video signal may also be used to increase the number of two-color combinations possible.

The diagram, Fig. 1, outlines the way these various signals are used. At the left is a subject—in this case a simple piece of artwork showing a white block on a black background. The monochrome signal (+V) represents the output of a monochrome camera used on this subject. The inverted signal (-V) is the same picture, electrically inverted in a separate amplifier. The blanking signal (BL) is regular mixed blanking, reduced to the same amplitude as the picture signal.

As an example, these signals are fed to the red, green, and blue inputs of a colorplexer. Note now the three signals. In the center area, representing the artwork, signal is now present in both the red and the green channels. Therefore, the colorplexer puts out a red-green or yellow signal for this area. In the background, signal is present in both the green and blue channels and the colorplexer provides a green-blue or cyan background area signal.

### How It Works

The number of different color combinations which are possible depends, of course, on the equipment available. First, the three signals just described provide 30 combinations with only patch facilities available. Second, if isolated switching is available to permit connection of one signal simultaneously to two of the colorplexer inputs, then 24 more are possible. Fig. 2 indicates these combinations of primary and mixture colors.

### Equipment Used

The photographs, Figs. 3 and 4, show the equipment being demonstrated at the NARTB convention in Washington. Fig. 3 shows the title cards used as a source of monochrome pictures. The small camera, in this case, is a TK-21 Vidicon camera, operating normally with the light supplied by two spot lights. The picture source is, of course, not limited to this method. Any conventional camera arrangement such as normally used for 2 x 2 or opaque slides may also be used. Fig. 4 shows the remainder of the equipment used, as it was located in the racks.

The actual circuit, in simplified form, is shown in Fig. 5. The three TA-3A Distribution Amplifiers provide the necessary isolation for feeding the TS-2A Switchers. The single line on the diagram actually represents three separate leads from each of the amplifiers, one going to each of the switchers. The TA-3A provided for polarity inversion is the only non-standard unit in the whole system. It has been modified to add one tube for a simple inversion stage at the input. Blanking must then be added to the inverted signal to establish proper black level. This is done with the regular sync addition circuits provided. Fig. 6 is

a schematic of these modifications. It should be noted here that this blanking addition process is critical as to timing. For this reason black background material is recommended. If white appears at the edges of a picture before inversion, then the added blanking must exactly cancel the blanking in the original picture. Any differences in timing or width will appear as severe transients. Also, the picture with black background will be easier to light evenly and to shade properly in the camera chain.

The attenuator shown is simply a potentiometer used to reduce the regular four volt blanking distribution level to video level for use as a white picture.

It may now be seen that either monochrome video (+V), inverted video (-V), or blanking (BL) may be fed to any or all of the colorplexer inputs in any combination.

### Results with This Equipment

As mentioned before, 54 color combinations are possible with this equipment layout. In fact two (2) more possibilities may be added by pushing all three buttons for either +V or V. This results in a return to monochrome, a good check on colorplexer and monitor balance. A chart of all these combinations is shown in Fig. 7.

Of course all of these combinations may not be practical for everyday use. First, some color combinations may not be artistically pleasing for on-air color service. Second, colors whose luminance values are similar may not yield adequate contrast on monochrome receivers. The color combinations enclosed in double-line boxes on Fig. 7 are probably most desirable.

FIG. 1. Simplified diagram of subject, signals, and resulting color picture.

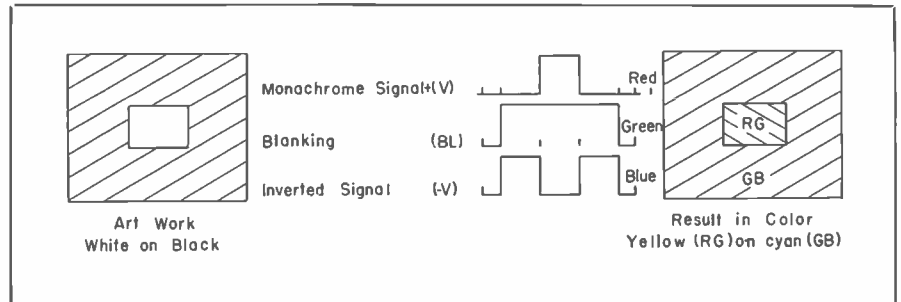

| FACILITIES |                       |                      |                                 |                      |
|------------|-----------------------|----------------------|---------------------------------|----------------------|
| Signals    | Patching <sup>1</sup> |                      | Isolated Switching <sup>2</sup> |                      |
|            | Art                   | Background           | Art                             | Background           |
| +V         | Primary               | Black                | Mixture                         | Black                |
| +V, BL     | Mixture               | Primary <sup>3</sup> | White                           | Primary or Mixture   |
| +V, -V     | Primary               | Primary              | Primary <sup>4</sup>            | Mixture              |
| -V         | Black                 | Primary <sup>3</sup> | Mixture                         | Primary <sup>4</sup> |
| -V, BL     | Primary               | Mixture              | Black                           | Mixture              |
|            |                       |                      | Primary                         | White                |
|            |                       |                      | Mixture                         | White                |
| +V, -V, BL | Mixture               | Mixture              | Mixture                         | Mixture              |

<sup>1</sup> Patch facilities—one colorplexer input at a time.  
<sup>2</sup> Isolated Switching to permit simultaneous connection to one, two, or all three colorplexer inputs. Also includes all combinations for patch facility method.  
<sup>3</sup> One primary color is also used in the mixture.  
<sup>4</sup> Primary is not used in mixture.

FIG. 2. Chart illustrating the relation between possible color combinations and the signals and selection facilities available.

FIG. 3. Source of monochrome pictures in NARTB demonstration. Show-card artwork is being used here in conjunction with a Monochrome Vidicon Camera.

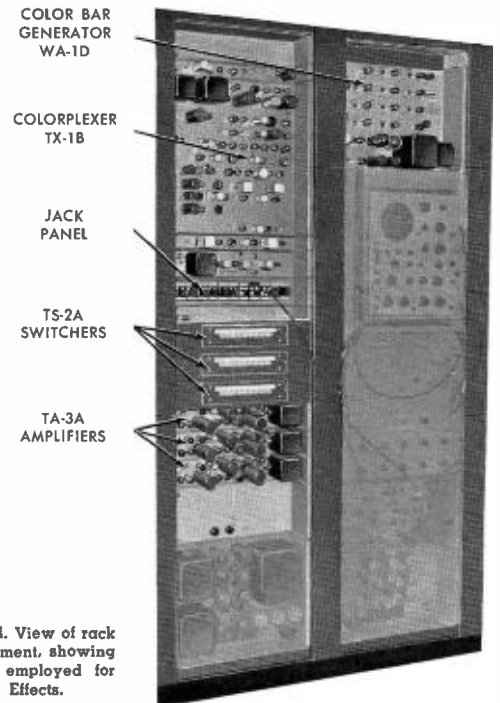
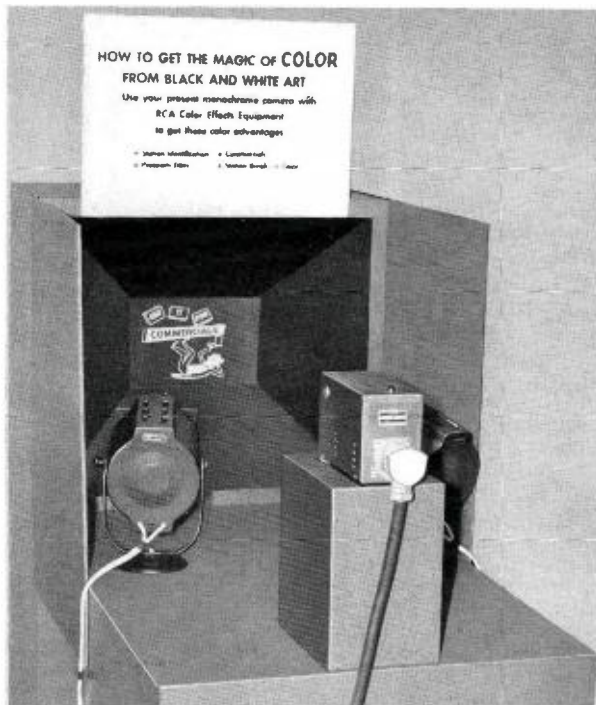

FIG. 4. View of rack equipment, showing units employed for Color Effects.



In order to avoid subcarrier overshoots, just as is done in the color bars, the input signals to the colorplexer should be run at 75% level. Referring again to the block diagram, Fig. 5, the video level at the camera output should be 1.0 volt to agree with present color camera practice. The input to the blanking amplifier should also be set at 1.0 volt with the attenuator. Then all three TA-3A's should be adjusted for

75% gain to provide 0.75 volt output signals. The colorplexer is normally adjusted for standard station level output. All of this means that color combinations containing white actually contain only 75% white.

In the demonstration equipment only three of the nine TS-2A Switcher inputs were used. It is worth mentioning a feature we did not use, in that a regular color bar

or color camera (simultaneous output) could be fed directly to the switcher group. Pushing three buttons in the same input row would then make the colorplexer available for tests or regular color operation. Thus it may become a spare for the colorplexer in a film or live camera chain. Or the reverse may be true; a colorplexer, already used in a camera chain, may be shared with the Color Effects operation.

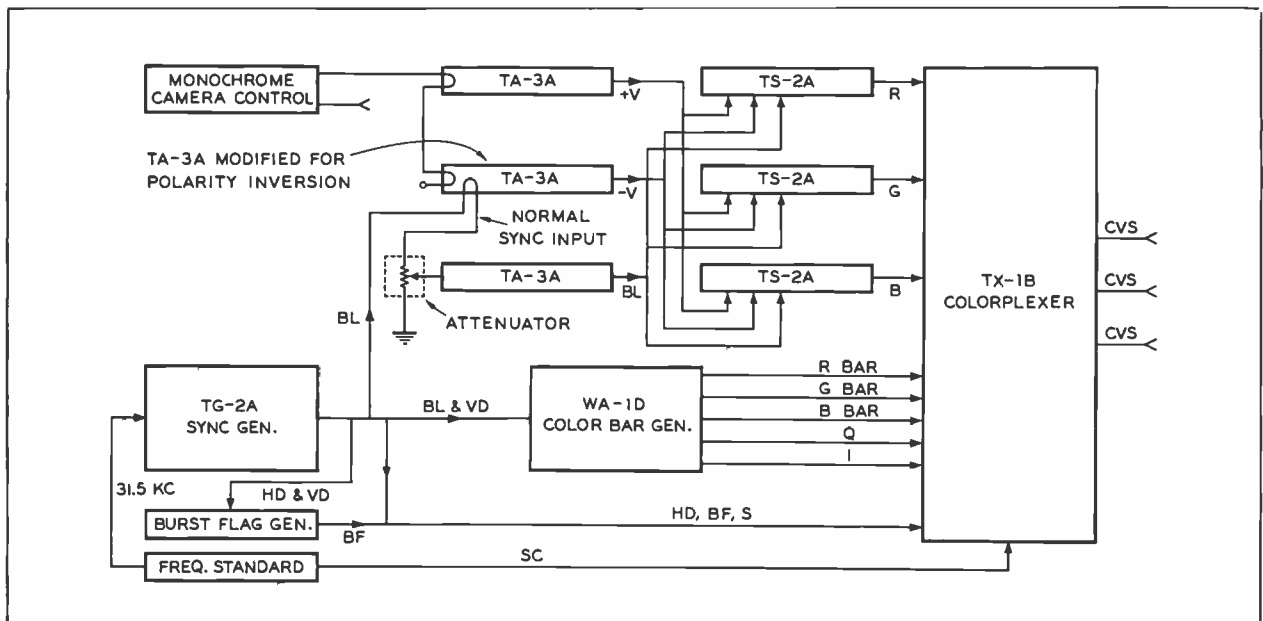

FIG. 5. Simplified block diagram of equipment used in NARTB demonstration.

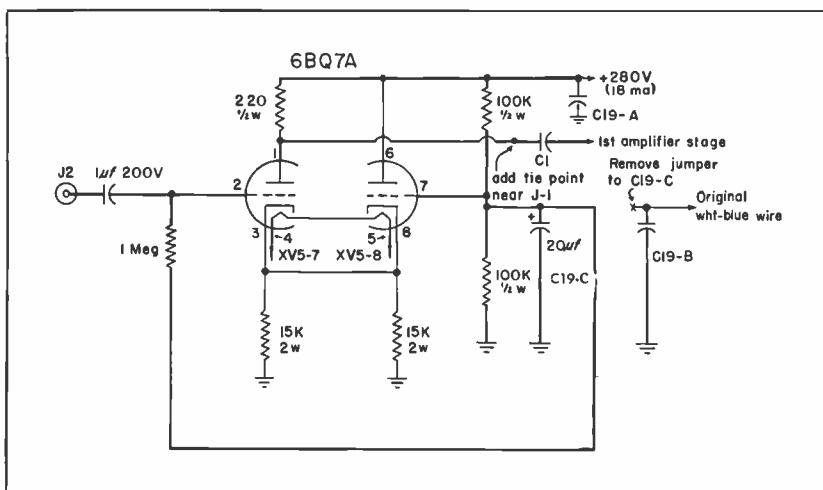

FIG. 6. Schematic of Polarity Inversion Modification for TA-3A Distribution Amplifier.

1. Locate a 9-pin tube socket on a bracket beside J-3.
2. Connect 6BQ7A as shown above.
3. One other change is required in the blanking addition circuit: For MI-26157 type amplifiers, remove R50; for MI-26157-A type, short R-47.

CODE:

- BF—Burst Flag
- BL—Blanking
- HD—Horizontal Drive
- VD—Vertical Drive
- S—Sync
- SC—Subcarrier
- R—Red
- B—Blue
- G—Green
- V—Video
- CVS—Colorplexed Video with Sync

## Chart illustrating all of the 56 possible color combinations

| ART           |                | BACKGROUND     |                |                |                |                |                |                | COLORPLEXER<br>INPUT |
|---------------|----------------|----------------|----------------|----------------|----------------|----------------|----------------|----------------|----------------------|
| COLORS        | W              | Y              | C              | G              | P              | R              | B              | Black          |                      |
| <b>White</b>  |                | BL<br>BL<br>+V | +V<br>BL<br>BL | +V<br>BL<br>+V | BL<br>+V<br>BL | BL<br>+V<br>+V | +V<br>+V<br>BL | +V<br>+V<br>+V | R<br>G<br>B          |
| <b>Yellow</b> | BL<br>BL<br>-V |                | +V<br>BL<br>-V | +V<br>BL<br>NO | BL<br>+V<br>-V | BL<br>+V<br>NO | +V<br>+V<br>-V | +V<br>+V<br>NO | R<br>G<br>B          |
| <b>Cyan</b>   | -V<br>BL<br>BL | -V<br>BL<br>+V |                | NO<br>BL<br>+V | -V<br>+V<br>BL | -V<br>+V<br>+V | NO<br>+V<br>BL | NO<br>+V<br>+V | R<br>G<br>B          |
| <b>Green</b>  | -V<br>BL<br>-V | -V<br>BL<br>NO | NO<br>BL<br>-V |                | -V<br>+V<br>-V | -V<br>+V<br>NO | NO<br>+V<br>-V | NO<br>+V<br>NO | R<br>G<br>B          |
| <b>Purple</b> | BL<br>-V<br>BL | BL<br>-V<br>+V | +V<br>-V<br>BL | +V<br>-V<br>+V |                | BL<br>NO<br>+V | +V<br>NO<br>BL | +V<br>NO<br>+V | R<br>G<br>B          |
| <b>Red</b>    | BL<br>-V<br>-V | BL<br>-V<br>NO | +V<br>-V<br>-V | +V<br>-V<br>NO | BL<br>NO<br>-V |                | +V<br>NO<br>-V | +V<br>NO<br>NO | R<br>G<br>B          |
| <b>Blue</b>   | -V<br>-V<br>BL | -V<br>-V<br>+V | NO<br>-V<br>BL | NO<br>-V<br>+V | -V<br>NO<br>BL | -V<br>NO<br>+V |                | NO<br>NO<br>+V | R<br>G<br>B          |
| <b>Black</b>  | -V<br>-V<br>-V | -V<br>-V<br>NO | NO<br>-V<br>-V | NO<br>-V<br>NO | -V<br>NO<br>-V | -V<br>NO<br>NO | NO<br>NO<br>-V |                | R<br>G<br>B          |



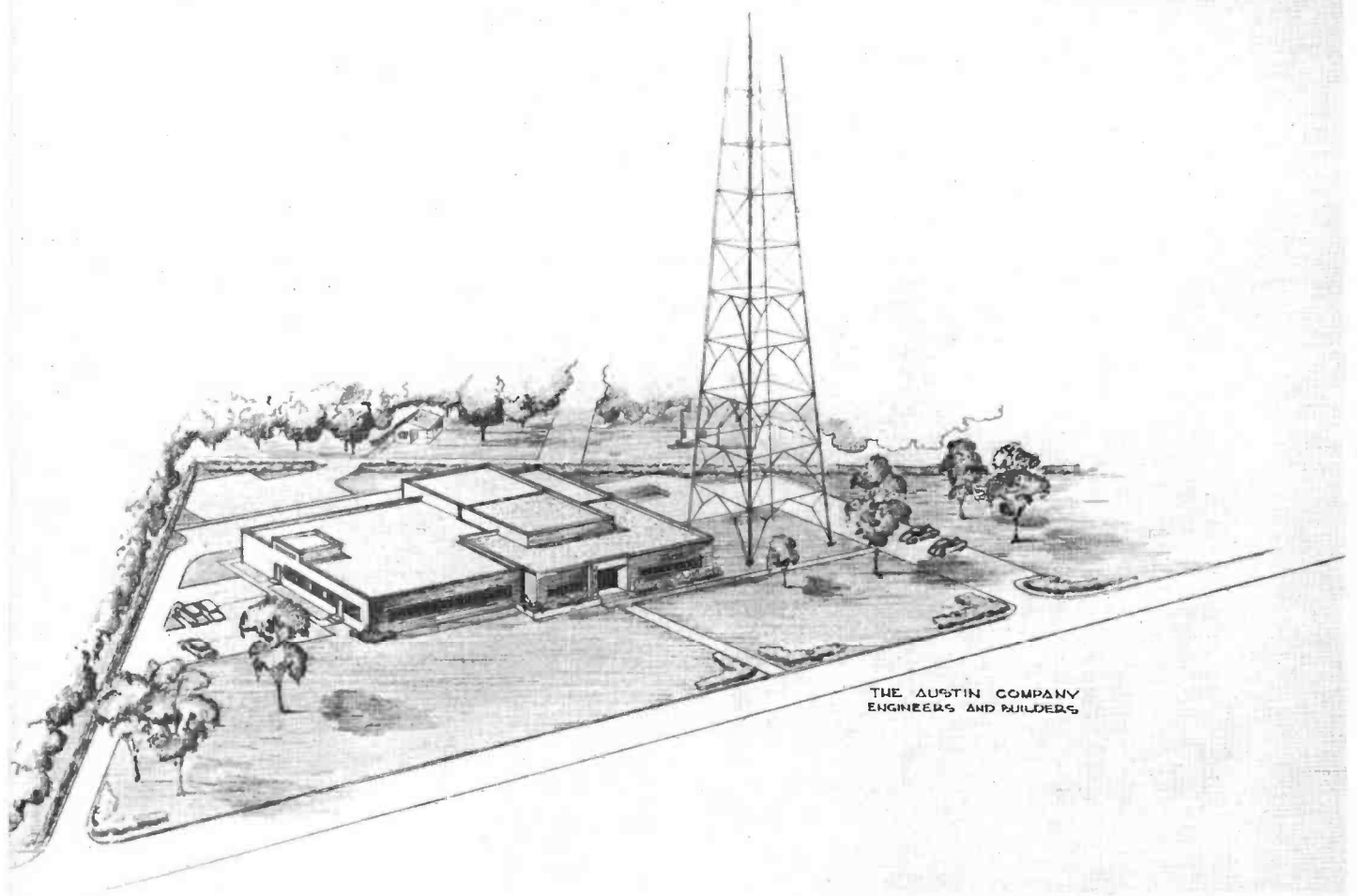

FIG. 1. Aerial perspective of the expanded WHIO Studio Building. Initial unit, with speckled roof, is at the right front.

# WHIO's NEW FACILITIES

Miami Valley Broadcasting Corporation Concentrates Radio and TV Operations In Treble-Sized Studio and Office Building

by  
**ERNEST L. ADAMS**  
 Chief Engineer, WHIO

In March of this year WHIO moved its radio studios and business offices to the WHIO-TV Studio Building on the Wilmington Pike (about five miles from downtown Dayton). The original WHIO-TV building was constructed in 1948 and was designed for television only. An addition to this building was constructed so that we could integrate the entire radio and television operation. The remodeling job included the construction of a radio studio section, an additional television studio, and the relocation of the control and projec-

tion rooms, as well as the addition of space for business offices and for other company activities. The design and construction of the new facilities was carried out by The Austin Company who built the original building.

The architect's drawing, Fig. 1, shows how the original building was expanded. The new addition is of red facebrick and limestone trim exactly matching the original construction. The expanded building is approximately twice as wide and of fifty per cent greater depth than the original. Austin engineers worked out the transformation from a very limited one-studio television layout to a complete broadcasting center with two television studios (one 50 x 63 feet), three radio studios, and

complete production, business and administrative offices with a minimum of structural changes.

The remodeled and expanded WHIO-TV, AM, FM building was designed to provide compact space for three general classifications: (1) Television, (2) Radio, (3) General Offices. It was planned that each operation could be run independently of all else and that certain common facilities would be available to more than one group. For example, a common news room and music library are used by both radio and television.

The northeast section of the building (left rear in Fig. 1) is allocated to radio, the south section (right half, Fig. 1) to



FIG. 2 (above). The new wing (left foreground) of the WHIO Building was designed to harmonize in appearance with the original unit (far right). Visitors to the building continue to use the original front entrance. Staff and artists use a new rear entrance, thus segregating traffic.

FIG. 3 (right). Robert H. Moody, Manager of the Miami Valley Broadcasting Corporation, in his new office in the WHIO Building. An adjoining conference room (door at rear) is provided for business meetings and client conferences.

television and the northwest section (left front, Fig. 1) to general offices. The corridors and lobby are so arranged that the traffic is moved throughout the building with a minimum of conflict. Studies made by the station management and design engineers over a period of nearly five years resulted in development of a functional plan which keeps the public and business callers, as well as office employees and talent, all out of each other's way. How this was accomplished is shown by the overall floor plan on the following page. Also on following pages are photographs and descriptions of the individual areas in the new WHIO building, as well as a description of the radio and TV equipment facilities.

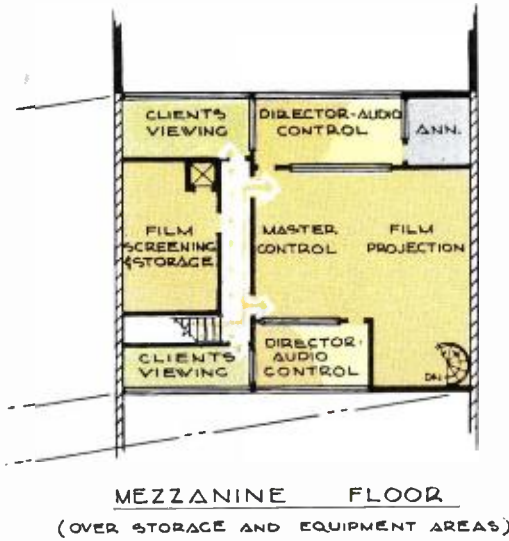







FIG. 4 (left). Floor plan of the expanded WHIO Building. Colored areas show how various activities have been centralized. Correspondingly colored lines show flow of various types of traffic (see legend). Note that location of various activities has been carefully planned to reduce "mixing", or "cross-over", of traffic lines to an absolute minimum. TV operations occupy the whole right half of the building. AM operations are located at the left rear, while business offices occupy the left front portion of the building. Location of the TV technical area (a two-story section) between the two TV studios promotes operating efficiency.



## WHIO BUILDING LAYOUT FACILITATES TRAFFIC FLOW

The most up-to-date ideas on increasing station efficiency by "traffic segregation" have been followed in locating the various facilities in the WHIO building. As the floor diagram, Fig. 4, shows each part of the operation is centralized as much as possible and corridors are laid out so that there is very little criss-cross traffic.

The new large-sized TV studio is located to the rear of the original studio, with the control and equipment rooms between the two studios. Thus all TV operations are concentrated in the right half of the building. An interesting feature of this part of the layout is the isolation of video control operations on a mezzanine which extends between the two studio control booths and adjacent clients' rooms. This permits the use of common video control equipment for programs originating in either studio, and separates video control personnel from the annoyances of distracting studio activities. The large master control room not only accommodates the console and all the film projection equipment, but also provides ample additional floor space for the installation of color television control units. Location of the console and other control equipment on the mezzanine, directly above the equipment room and equipment racks, made it possible to hold all of the conduit runs to a minimum. It provides 100% accessibility for all control wiring which is carried through openings in the mezzanine floor slab to open, expanded metal cable baskets suspended from the underside of the slab. In addition to the extensive prop storage space within the two TV studios themselves, more than 3,000 square feet of

floor space has been allocated to this function in the areas directly adjoining the studios and the garage.

Administrative offices and a large, conference-audition room extend across the front of the new wing. The entire back section of this wing is occupied by the three AM studios which have been grouped around a single master control room. The intervening area in the new building has been subdivided by movable, steel and obscure glass bank-type partitions which separate the departmental functions (commercial and contract, traffic, bookkeeping, production, etc.) and afford a maximum of privacy. Music library and news rooms are centrally located along the corridor which extends between the AM and the TV studios.

Handling of visitors is an important consideration in the design of any television and radio facility. The WHIO Building was planned to permit visitors in all areas with a minimum of interference to the workers. Audiences for television shows normally enter through the front entrance. They are directed along the south corridor to either of the two studios. Toilets and a drinking fountain are convenient. Viewing rooms are provided for each television studio and visitors may observe the control room through the glass panels from the corridor.

The area designated on the plot plan as FM transmitter houses our original RCA TT-5A television transmitter, which is maintained for emergency use, as well as the 20 KW FM transmitter.

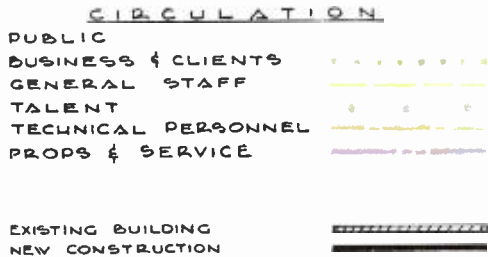

THE AUSTIN COMPANY  
ENGINEERS AND BUILDERS





FIG. 5. WHIO's new TV studio is 50 feet wide by 63 deep. Elevated director's booth makes it possible to place sets around all four sides.

## WHIO's NEW TELEVISION STUDIOS

The original WHIO-TV Building contained a single 30' x 50' studio. In order to provide for greater flexibility in programming, for rehearsing without danger of program interruption, and for future color operation a second larger studio was considered a necessity.

The new studio, located to the rear of the original studio, is 50 feet wide by 63 feet long and has a ceiling clearance of 20 feet. Because the control room is elevated

it is possible to place sets around all four sides of the studio.

Fibrous acoustic material is employed on all walls and the ceiling of the new studio. This studio is designed for ultimate light levels in the order of 300 foot candles. Its present light level is about 150 foot candles. The lighting console is installed in the studio under the control room window. It has a patch panel for selecting lights and four 10 KW dimmers. Light

supports and wiring devices are suspended by chains from the roof bar joists. Hooks at the end of the chains permit easy positioning and height adjustments.

The original 30' x 50' television studio has been retained with minor changes and is being refitted and relighted. Air conditioning and lighting capacity will permit 300 foot candles or better over the staging area. This studio is equipped with a complete operating kitchen.

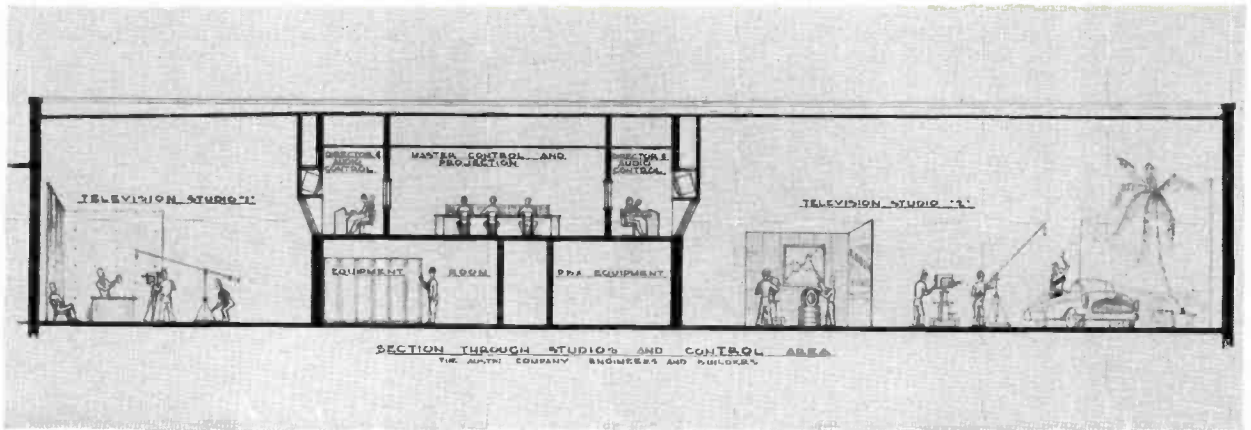

FIG. 6. Section through the two TV studios and the two-level control core. Master control equipment can be used for both studios.

## CENTRALIZED TV TECHNICAL FACILITIES

WHIO's control rooms and studios for television are arranged with the idea of achieving the flexibility of a complete two studio, two control room operation while at the same time retaining the efficient simplicity of a single studio layout.

The television technical area is located in the center of the building between the two television studios. This is the only two-story portion of the building. By locat-

ing the control room-projection room area on the second floor good visibility to the studio was secured, and space directly below was made available for power supply racks and workshop.

The control area (see Fig. 4, Page 42) is split into three general parts—a production booth for each of the studios and a combined video control and projection room.

The production booths are unusual in that they contain no video control or switching gear. They are equipped with 17-inch picture monitors for each picture source—studio cameras, film cameras, network, etc. These monitors are located directly above the studio window and about 48 inches above the floor. They were kept low to facilitate rapid and repeated changes of vision as the director's eyes are moved from copy on desk to studio and monitors.

FIG. 7. View from the TV master control room through the director's booth into the studio. Director and audio operator (in booth) have an unobstructed view of studio, see camera pictures on monitors mounted in wall above studio window. Announcer's booth is at extreme right; clients' booth at far left.



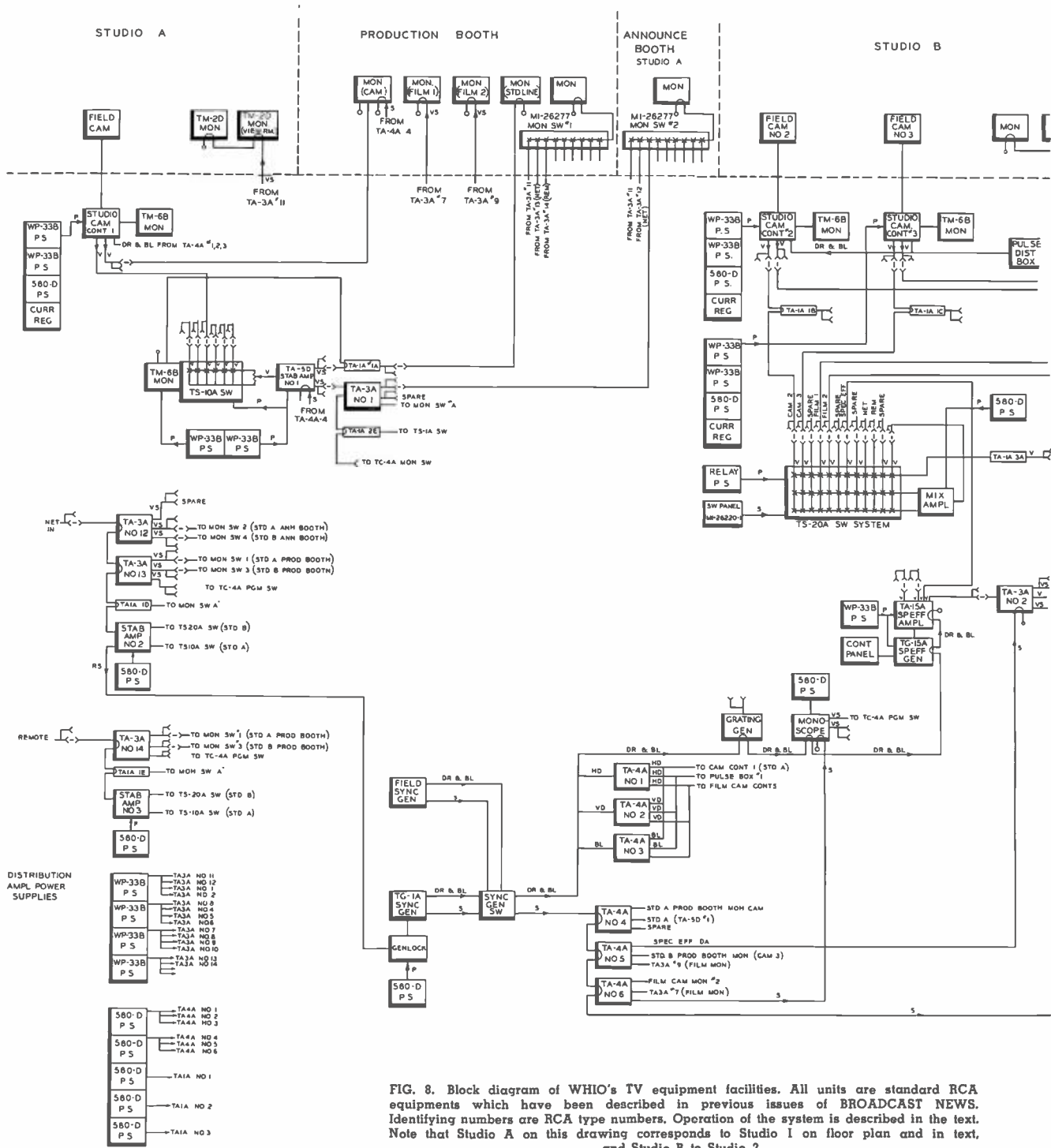
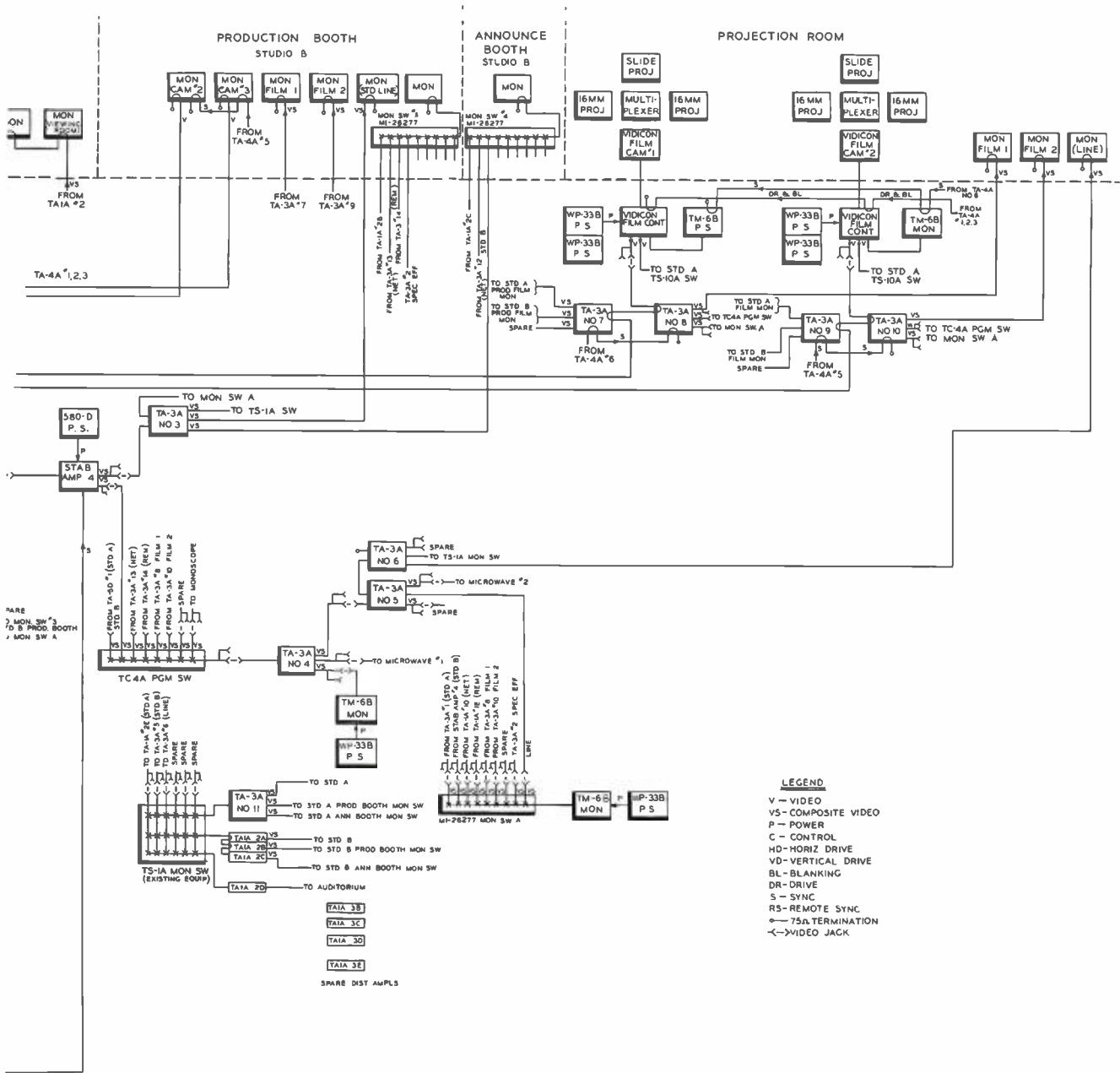

FIG. 8. Block diagram of WHO's TV equipment facilities. All units are standard RCA equipments which have been described in previous issues of BROADCAST NEWS. Identifying numbers are RCA type numbers. Operation of the system is described in the text. Note that Studio A on this drawing corresponds to Studio 1 on floor plan and in text, and Studio B to Studio 2.





Also in the production booth are complete audio facilities including a six channel audio console and a microphone patch panel.

The video control and projection equipments are combined in one room. This we believe is a logical combination. It has been found that the video operator and the projectionist can be of mutual assistance when so closely grouped. The prin-

cipal objection to this arrangement was noise from the film projectors. This has been reduced to a minimum by the careful placement of acoustical material and the use of the relatively quiet RCA TP-6B projectors.

The video console is arranged to provide a program switcher for each studio. For studio "2" an RCA TS-20A switcher is used, and for studio "1" an RCA Type

TS-10A. Network and film cameras appear on both switchers, and studio cameras only on their respective units.

Output switching is done with the audio-video switching unit from an RCA TC-4A console. Output from either the TS-20A or the TS-10A studio switchers may be connected to the transmitter line, or film and network may be fed directly to the transmitter line by-passing the studio switchers.



FIG. 9. WHIO's TV Master Control Room contains not only master switching equipment but also all camera controls and film projection equipment. Studio 2 camera control units are at left of main console; Studio 1 camera controls are at right; film camera controls, preview and line monitors are in the center.

FIG. 10 (below). View of the engineers' shop and equipment room. Note cables coming through floor from master control directly above. These are carried in cable baskets to drop-out locations above equipment racks which are out of sight at left.

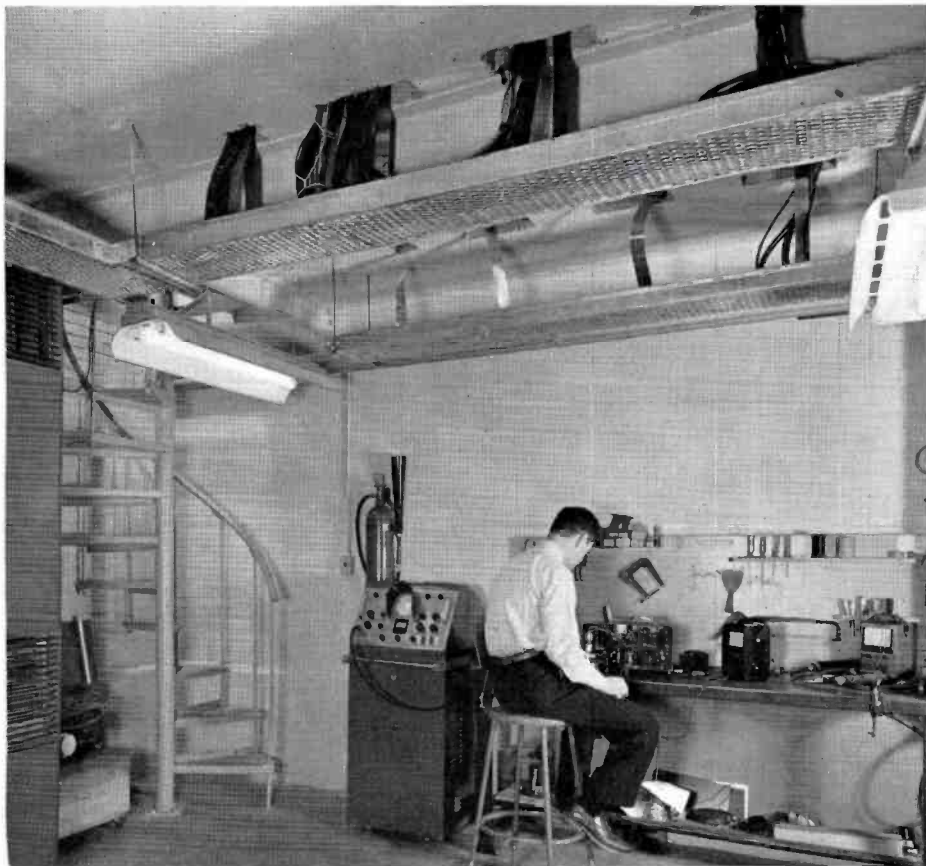

The video console sections are set up with the studio "2" switcher and its studio cameras at one end. The film camera controls and the preview monitor are in the center and the studio "1" switcher and controls at the other end.

The video operator makes all of the camera adjustments and does all switching on direction from the program director in the production booth. Headphones and intercom speaker are used for communications. One video operator can handle most programs including shows from either studio. When two programs are originated simultaneously a second video operator is used at the console.

On the first floor, directly below the control room, are located the power supplies, sync generators, A T & T terminal equipment and other miscellaneous equipment. Wiring is run from the top of the power supply racks by means of cable baskets (Fig. 10) to the equipment in the control room above. Cable baskets provide an inexpensive and flexible means of handling interconnecting wiring.



FIG. 11 (right). WHIO's TV transmitter building is located on a ridge five miles southwest of Dayton. Base of 1104-foot tower is visible at left.

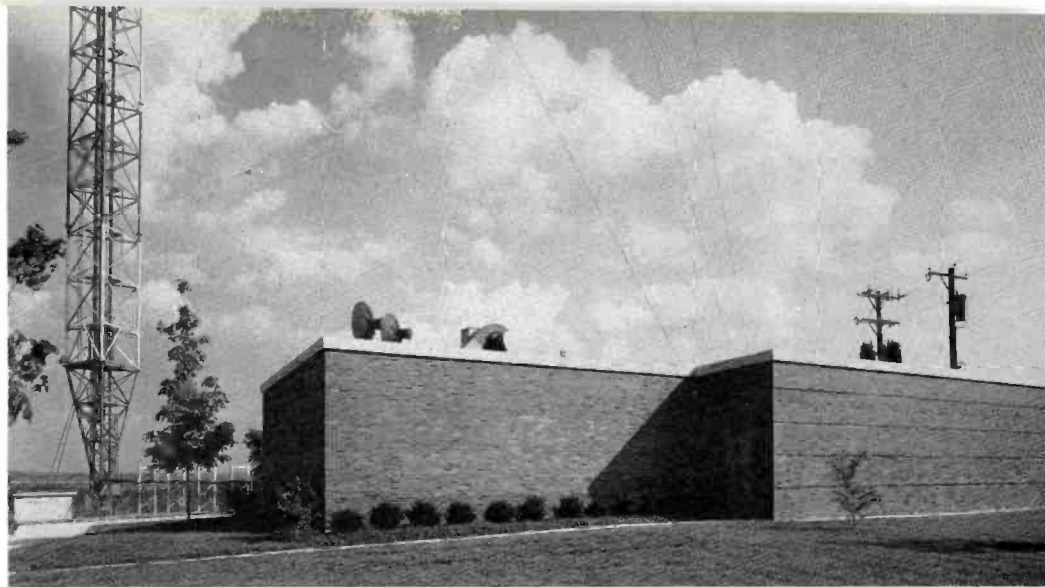

## WHIO-TV TRANSMITTER INSTALLATION

When WHIO-TV went on the air in 1948 an RCA TT-5A Transmitter was installed in the present building. A six-bay RCA Superturnstile was mounted, along with an FM Pylon, on a 417-foot tower adjacent to the building. In 1954 a new transmitter building and a 1104-foot tower were erected on a ridge five miles southwest of Dayton. An RCA TT-25BH Transmitter was installed in the new building and an RCA TF-12AH Superturnstile mounted on the new tower. The added height and power have greatly increased WHIO-TV's pri-

mary coverage as well as quality of service in fringe areas.

Space was provided in the new transmitter building for installation of the original TT-5A Transmitter as an auxiliary for emergency use. At the present time the TT-5A is still in its original place in the studio building (where it is available for emergency operation). However, it will be moved in the near future to the new location.

The new transmitter building, like the studio building, was designed and con-

structed by The Austin Company after a careful study of WHIO-TV requirements. The operating room is air-conditioned by a package-type air conditioner. Electrostatically-filtered air is brought in through floor ducts to the transmitter enclosures and exhausted by means of overhead ducts. Equipment units are arranged in a U-shape about the operating position as shown in Fig. 12. The TT-25BH is in the center. Test and input equipment is at the left; space for the TT-5A at the right. The control console is in the center.

FIG. 12. WHIO's RCA TT-25BH Transmitter is the center of a U-shaped equipment layout. Left of the U consists of racks for input and test equipment. Right of the U will be formed by WHIO's original RCA TT-5A Transmitter which will be moved from studio building and used as an emergency unit.







FIG. 13. WHIO's main AM studio. Walls are covered by perforated asbestos board which covers acoustical materials of various densities chosen to provide an ideal frequency curve. Smaller AM studio can be seen through window at left and AM control room through window at rear.

## RADIO SECTION OF THE WHIO STUDIO BUILDING

Considerable thought was given to the arrangement of the radio section of the WHIO building. The aim was to provide maximum convenience and flexibility and yet insure efficient economical operation. The plan finally decided upon includes a master control room around which are grouped two studios, an announce booth and an equipment room. The studios are 21 feet by 33 feet, and 15 feet by 20 feet. The announce booth is 8 feet by 11 feet.

The equipment is arranged so that studio "B" in addition to serving as the announce and turntable studio, may be used

as an auxiliary control room. The announcer may control microphones in studio "A" as well as his own mike and turntables, or the main control room may be used for either or both studios in conventional manner. This arrangement provides maximum flexibility for all requirements.

The small announce booth off the main control room is designed for transcribing short spot announcements and other miscellaneous types of speech that are frequently required in a radio operation. Delayed disc jockey programs may also be transcribed from this booth.

An RCA BCS-11A switcher is installed in the main control room. It is used to feed independent or simultaneous programs to the AM transmitter, FM transmitter and recording equipment. An RCA BC-2B console is used in conjunction with this switcher. The operator sitting at the master control position can look directly into both studios and the announce booth. Equipment racks are built into the wall between the control room and the equipment room. This concentration of all AM operations in one close-knit unit provides for maximum efficiency and convenience.



FIG. 14. AM Master Control Room in new WHIO Studio Building. The three AM studios are grouped about this control room so that there is direct visual communication between all three and the control room. An RCA BC-2B Console and RCA BCS-11A Switcher provide flexible facilities with a high degree of operating efficiency.



FIG. 15. This well-equipped music room is typical of a number of WHIO facilities which serve both AM and TV. Located on the corridor between AM and TV operation areas this room contains record racks, filing cabinets, a turntable, and two small soundproof listening booths (just out of sight on the right).





FIG. 16. This spacious and well-appointed conference room adjoins the manager's office in the new WHIO Building. The lighting system is unusual. Two 6-foot slimline tubes have been installed end-to-end and are supported by special steel channels which extend from wall to wall at 2-foot intervals. The channels also support V-shaped, perforated metal acoustic baffles. By mounting the tubes 18 inches below the reflective ceiling and operating them through remote ballasts, which are easily accessible on the opposite face of the wall shown here on the right, the engineers provided ideal lighting and eliminated any possibility of operating noise.

Speakers and two built-in viewing screens in the paneled end wall supplement the movable TV receiver. One side accommodates a rear projection movie screen and the other is used for viewing closed circuit as well as scheduled television programs. The nature of the lighting permits comfortable viewing of movies and television with 1/3 of the room lighting (in the area farthest from the screens) in operation. Drapes on the left wall conceal a narrow band of windows which overlook the Wilmington Pike.

FIG. 17. This lounge space, directly opposite the executive offices at the Miami Valley Broadcasting Corporation's new headquarters is also convenient to the business offices which can be seen on the right side of the corridor. Random walnut Flexwood paneling has been used in the curved wall section which has a luminous ceiling. The acoustical tile ceiling with recessed fluorescent lighting in the background is typical of treatments throughout the general offices.

Ballasts serving the lighting units in the executive suite are mounted behind the louvered access boxes on the corridor wall (left).



## RECEPTION AREAS OF NEW WHIO BUILDING

The attractive, modern steel and glass entrance of the original building continues to serve as the public entrance to the WHIO building. A new entrance, at the rear, has been provided for employees so that they will not need to mingle with the visitors to the station.

In keeping with the plan for separation of traffic, the building has three separate and distinctively decorated reception areas—one for the public, directly inside the original entrance where generous provision has been made to handle persons visiting

the studio for audience participation programs; a second for business visitors, adjoining the administration offices, and a third for employees, directly inside a new entrance from the staff parking lot at the rear of the structure.

Recessed fluorescent lighting and acoustical ceilings have been installed throughout all the office and control areas as well as the AM studios, where rubber tile flooring has been installed. Other parts of the new building have vinyl tile floors which are attractive as well as wear-resistant.

Mechanical requirements of the enlarged structure have been met by supplementing facilities installed for the original unit with a 26 horsepower gas-fired boiler and two reciprocating type refrigerating compressors with an aggregate capacity of 100 tons to serve three air-handling units. These units have been arranged to serve studio, office and work areas, and can be operated individually or in combination depending upon requirements at any given time. A separate, self-contained 10-ton air-conditioning unit serves the room containing the television equipment racks.



## How to turn talk into trucking profits ... with RCA Mobile Radio!

Motor carriers have been quick to appreciate the competitive advantages of RCA 2-Way Mobile Radio for pickup and delivery service in terminal operations. It gives customers faster service—and faster service means more pickups, more ton miles, more profits.

The dispatcher shown above can be in touch with all his drivers instantly. RCA 2-Way Radio makes it easy for him to combine pickups with deliveries, avoid jams at the terminal, send troubleshooters to breakdown points.

RCA 2-Way Radio, for either 6 or 12

volt operation, is designed for rugged service, with heavy-duty steel case, flame-proof battery cables. It is backed by the RCA Service Company's nationwide installation and service. And most important—it carries the name and reputation of RCA, world leader in radio and electronics.

For free booklet—"New Profits for the Trucking Industry with RCA 2-Way Radio"—or for information on other RCA electronic products, write to RCA Engineering Products Division, Dept. TD-163, Bldg. 15-1, Camden, New Jersey.



The world's best name for quality in electronics

**RADIO CORPORATION of AMERICA**

**Choose RCA electronic products for better business!**



RCA Beverage Uncaser automatically unloads empty bottles from cases, loads bottles onto washer. Adaptable to all washers, many bottle and case sizes. Increases bottlers' efficiency, reduces breakage.



RCA Industrial TV watches plant processes, protects property, helps instruct, lets banks verify signatures centrally. Industries send TV cameras where it's too hot, too dangerous or too impractical to go.

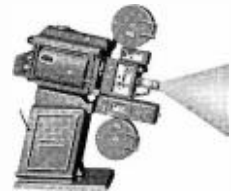

RCA Theatre Equipment leads the field with installations in a majority of U. S. theatres... indoor and outdoor. The complete line includes everything for a modern theatre... from projectors to carpeting.

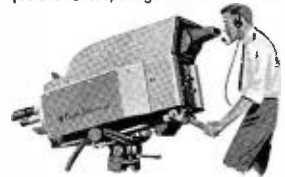

RCA TV Cameras are used today in a large number of the nation's television stations. They are part of a complete line of very high quality equipment which RCA supplies for radio and television broadcasting.



RCA 16mm Projectors are lightweight, compact, precision-built and simplest to operate. They're widely used for selling, training, demonstrating, teaching. Designed to use optical or magnetic sound track.



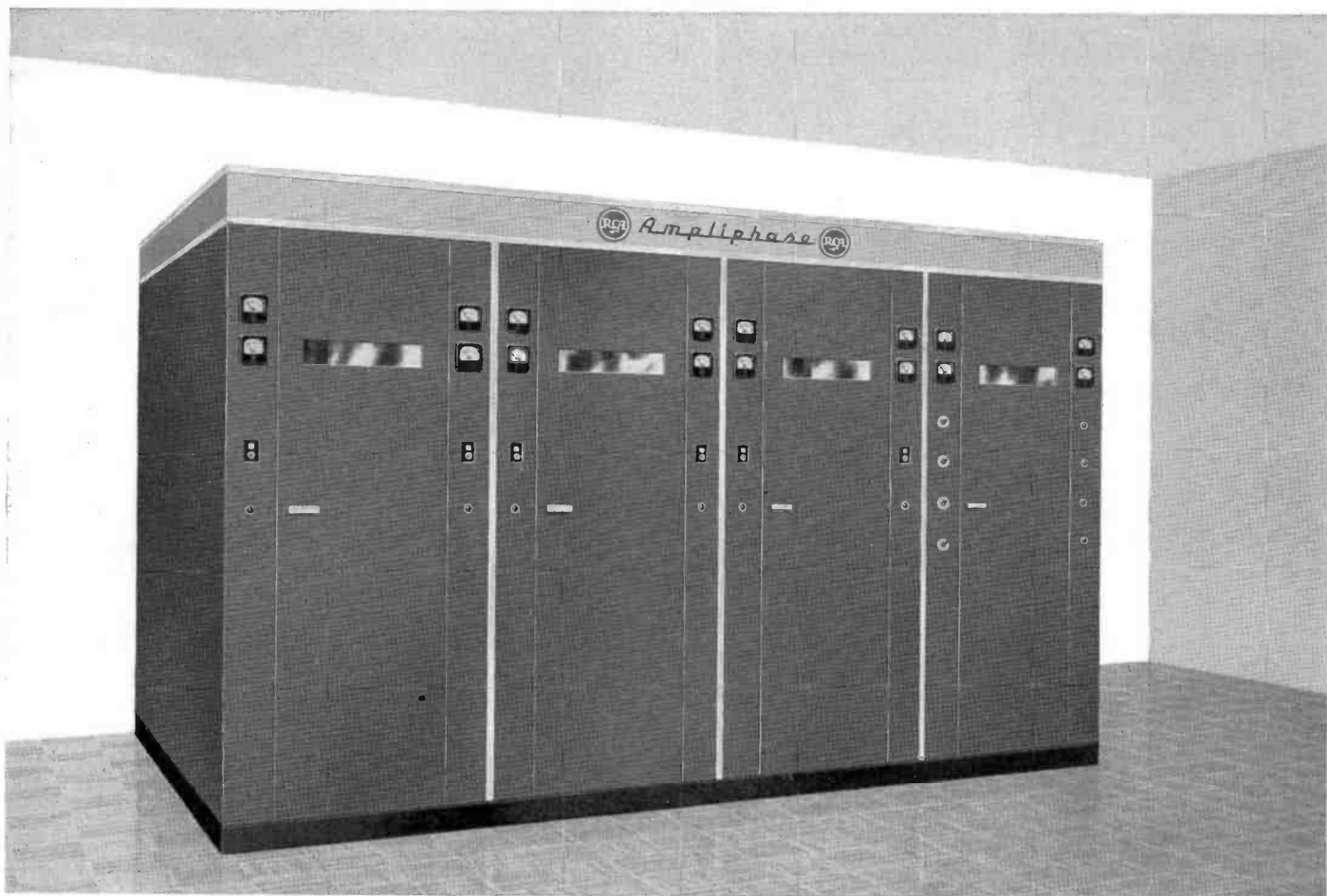

FIG. 1. Housed in only 4 cubicles, the RCA Ampliphase 50 KW AM Broadcast Transmitter offers many desirable features . . . low operating and tube costs, building space saving—often permitting replacement without loss of air time.

## THE RCA "AMPLIPHASE" FIFTY A NEW CONCEPT IN AM BROADCAST TRANSMITTERS

The RCA type BTA-50G transmitter is a new 50 KW AM transmitter engineered to meet present day AM radio requirements. The transmitter has many features particularly tailored to anticipate future requirements such as economy of space, economy of installation, and low cost tube complement. To stations contemplating equipment replacement the BTA-50G offers many advantages such as a self contained air cooling system requiring no inlet air ducting, built-in wiring ducts requiring no floor trenches, floor space requirements so small that a minimum of disruption of existing facilities will be required during installation. See Fig. 1.

The choice of a modulation system requiring a minimum of tubes and other

by **C. J. STARNER**

**J. Q. LAWSON**

**C. D. MULFORD**

RCA Engineering Products Division

components adds to dependability and a generous safety factor is provided in all components. Space is also provided for a completely independent and remotely switchable spare low level exciter/modulator unit.

A very high degree of r-f shielding results from the type of cabinetry used to house the equipment which, in conjunction with the high harmonic attenuation included in transmitter output circuits, will cope with imminent restrictions on spurious radiation.

### Phase to Amplitude Modulation

The phase to amplitude system of modulation has been used successfully both in this country and in Europe. Its use has been quite limited until now, however, because of the lack of high power tubes with the proper characteristics.

The system is one in which the r-f signal is phase modulated by the audio intelligence at a very low level and then amplified by high gain class "C" amplifiers to the desired power. The high power phase modulated signal is then converted to an amplitude modulated signal in a common load.

Reference to Fig. 2 will show that a single crystal oscillator is fed to two independent r-f channels through appropriate

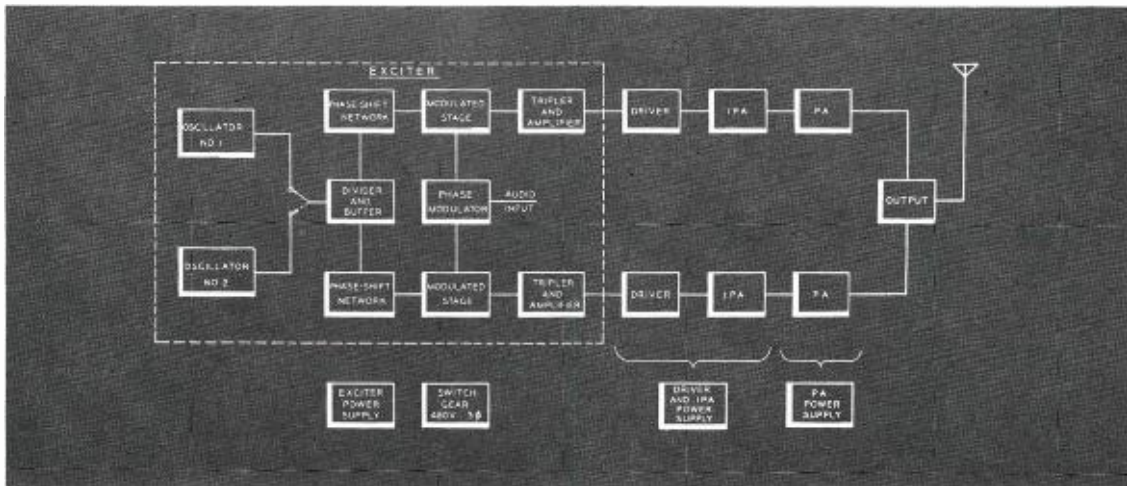

FIG. 2. Simplified Block Diagram of BTA-50G Ampliphase Transmitter.

phase shifting networks so that two r-f carriers are produced which are out of phase by  $135^\circ$ .

The r-f currents from these two r-f chains, when impressed on a common load, combine vectorially to produce the carrier value of output current. This load current is shown as vector OA (Fig. 3), current from the two r-f chains shown as OB and OC. It can be seen then that if modulation is applied so as to shift the phase of OB with respect to OC, the output current and output power will change accordingly. If the phase of OB with respect to OC is changed to the position shown as OB<sub>1</sub> and OC<sub>1</sub>, then OA will be reduced to zero and the output power to zero, corresponding to trough of modulation.

Conversely, if the phase difference between OB and OC is changed to that shown as OB<sub>2</sub> and OC<sub>2</sub> then value of OA will increase accordingly. When the phase difference between OB and OC is reduced to 90 degrees, it can be readily seen that the output current will be doubled, with respect to carrier current and the power will increase to four times carrier power, corresponding to peak of modulation.

A total phase excursion of  $\pm 22.5$  degrees is then required for 100 percent amplitude modulation. In the BTA-50G a process of frequency division and multiplication reduces this requirement to  $\pm 7.5$  degrees from the phase modulator. It can be shown that the instantaneous power output over the modulation cycle follows a cosine squared curve. Over the portion of a cosine curve encompassed by this angular deviation, departure from linearity

is very small. Likewise, good linearity is easily obtainable from a simple phase modulator over the angular range required for 100 percent modulation. Good overall modulation characteristics are thus obtainable without the use of over-all feed back.

#### Circuit Description

Reference is made to Fig. 2 which is a block diagram of the BTA-50G. R-f is

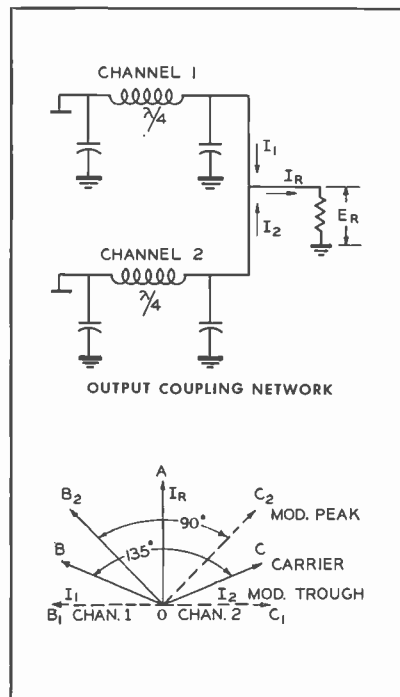

FIG. 3. Vectorial representation of phase-to-amplitude modulation process.

generated by a crystal controlled oscillator, operating at carrier frequency. This frequency is divided to 1/3 carrier frequency and then separated into two channels differing in phase by 180 degrees. Each signal then passes through a phase shifting network so adjusted that a phase difference of approximately 135 degrees exists between the two signals. This phase difference represents unmodulated carrier power output. Modulation is applied at this point to each r-f channel by a variable resistance type of phase modulator.

At the output of the phase modulator, the r-f signal has a phase excursion of approximately  $\pm 7.5$  degrees when modulated 100 percent. Due to this small angular excursion, a simple modulator using one-half of a 5692 triode can be employed. The modulation process consists of the injection of a variable resistance into the plate tank circuit of the 5693 modulated stage in accordance with the modulation intelligence. This variable resistance is obtained through the use of a grounded grid cathode follower stage utilizing a 5692 triode.

The output of the modulated stage is then fed through a buffer stage using one-half of a 5692 triode, thence to a tripler stage using the other half of the same triode. In the latter stage, the r-f frequency is returned to the output frequency, with a resultant gain in phase modulation to approximately  $\pm 22.5$  degrees. The power level after the 1614 amplifier is in the order of 5 watts, sufficient to adequately drive the following class "C" amplifier stage. This stage uses a 4-250 tetrode, which in turn drives a 5762 air cooled



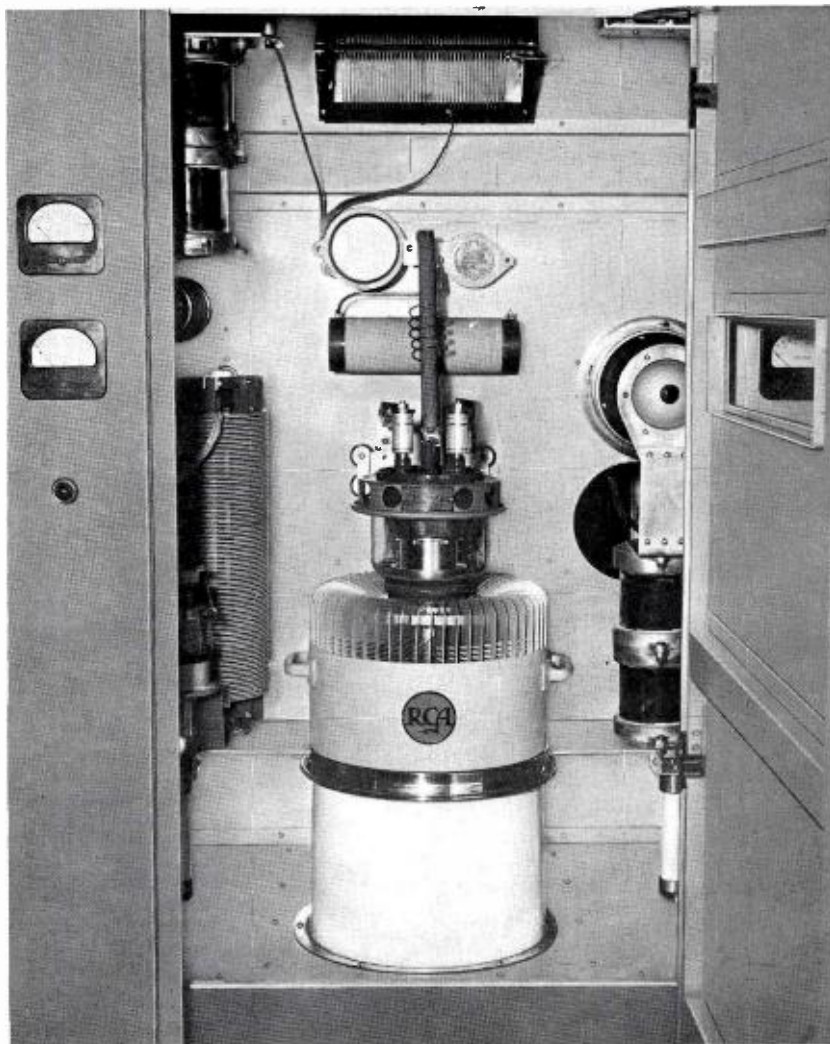

FIG. 4. Photo of output stage showing 5671 forced-air-cooled triode and associated circuitry components.

triode, operating as a grid modulated amplifier.

Since the output 5671 tubes must supply a load current that increases in value at peak of modulation to four times that required at carrier level, an increased driving voltage as well as increased bias voltage is necessary if the efficiency is to be maintained at peak of modulation. The converse is true over the negative portion of the modulation cycle. These requirements are met by grid modulating the 5762 driver, by use of grid leak bias, and a grid to grid loading resistor on the 5671 output tubes. The grid to grid load absorbs approximately one kilowatt of r-f driving power. Due to the varying phase angle between the 5671 grids over a modulation cycle, this

power absorption is essentially constant over the entire modulation cycle thus reducing materially the variation of the load resistance seen by the modulated driver.

The PA output circuit is a conventional pi-network type of tank circuit. Each tube has its own tank circuit, with a common output shunt element. Each network is set-up as a 90 degree network with the characteristic impedance required to convert the load resistance to the value required for optimum operation of the PA tube. Subsequent operational tuning is accomplished by adjusting the input shunt element, to provide a non-reactive load for the tube. Output stage is shown in Fig. 4.

In line with recent concepts concerning degree of suppression of spurious radiation,

a completely shielded low pass filter is incorporated in the BTA-50G output. A two section low pass filter is used. Each section is a tee network, and each inductive series element is completely shielded. A tuned series section is used to provide added attenuation for the second harmonic.

During periods of 100 percent modulation the 5671 power amplifier tubes require 15.0 KV DC at 7.5 amperes which is obtained by using 12 5563A mercury vapor thyatron in a three phase double way rectifier circuit. Each pair of 5563A tubes is operated in parallel for two reasons. First, the 5563A is an economical rectifier tube with a good life record in more severe service. Secondly, the disturbing surge effects of tube arc starvation are greatly reduced since one tube would momentarily carry the total current if the other failed to fire. This self protection feature is particularly advantageous at the voltage level at which this rectifier operates. A further degree of self protection is assured by the control grid of each 5563A which, when connected to its cathode through a suitable resistor, will tend to prevent build up of destructive arcs.

Two other plate voltage supplies, 5.0 kv and 2.5 kv, are supplied by a three phase double way center tapped rectifier using 6 8008 tubes. Bias voltages for all tubes are supplied by single phase full wave metallic rectifiers, portions of which are regulated by VR tubes.

The High Power distribution equipment for the transmitter consists of an electrically operated air circuit breaker, and a manually operated Delta-Wye switch which feed both the 15.0 KV rectifier and the 5.0/2.5 KV rectifier. The remaining transmitter power is distributed through a manually operated Distribution circuit breaker to a 460 to 230 volt distribution transformer to voltage regulators and thence to the various low power distribution circuit breakers.

The control of the transmitter is accomplished from the front of the Rectifier and Control cabinet with provisions made to allow control from a remote point. Lamps which show the status of the transmitter control circuits are also mounted on the front of this cabinet. The control ladder is arranged and interlocked so that the transmitter can either be turned on by operating the control switches in sequence or by leaving all control switches in the ON position with the exception of the start switch, which when operated to the ON position allows the transmitter to automatically come on.

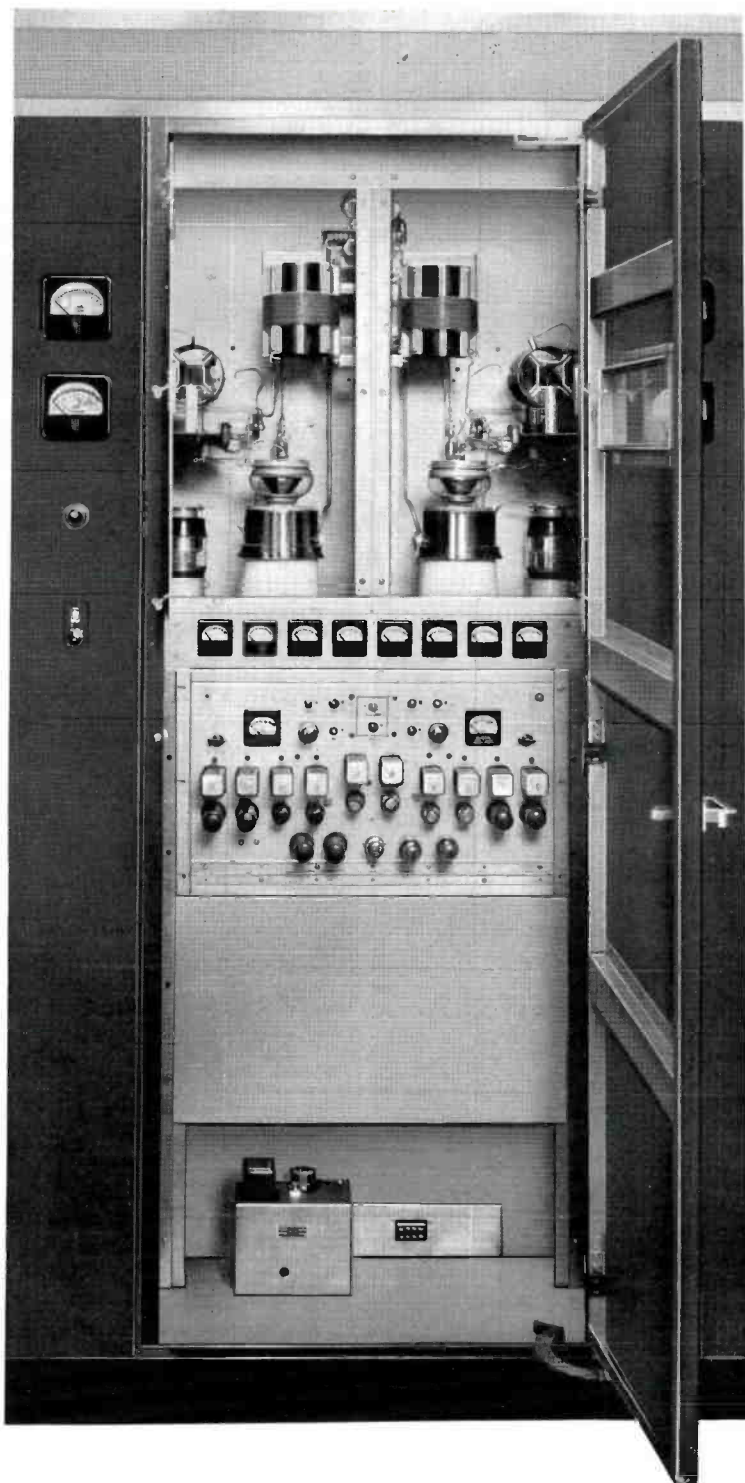

FIG. 5. View of exciter unit showing (from bottom to top) crystal-controlled oscillator and spare position, space for optional spare modulator unit, actual modulator unit, indicating meters and dual driver and IPA stages divided by shielding wall.

The two types of overload circuits used in this transmitter are the current type, instantaneous or time delay, which are connected directly in the tube circuit and rectifier ground leads, and the thermal magnetic circuit breakers connected in the AC power leads used as convenient back up protection and disconnect switches. The transmitter circuitry is such that an overload will either lock out the plate circuit or allow a single reclosure which will reset if there are no further overloads. In either case when a lockout position has been reached, the transmitter can be reset by means of an overload reset control. The principal overload relays have indicating flags so that even after the overload has been cleared there is a record of which overload has operated. As an aid in determining rapidly where a fault has occurred, there are four indicating lamps, one on each cabinet, which light when the fault occurs and indicate in which cabinet the fault occurred.

Other features of the control circuit are indicating lamps on each cabinet which indicate the status of the interlocks in that particular cabinet and a system of Carrier Off protection which does not operate the plate circuit breaker to the OFF position but instead biases off a low level stage momentarily to allow the radio frequency fault to clear itself.

#### Mechanical Features

In general, the transmitter layout consists of three basic parts: the four in line cabinets which contain the major part of the transmitter; the wall mounted switch-gear components; and the main plate transformers. The floor plan, Fig. 9, illustrates a typical layout of the complete equipment.

It is desirable to leave a passageway at the right end of the front line cabinets since the circuit breakers and overload relays are most accessible from this end of the transmitter. The layout of the front line cabinets is such that a common exhaust duct can be used to carry off heated air from the transmitter.

In keeping with the theory of making this transmitter adaptable to existing transmitter buildings, the main distribution components are wall mounted as shown on the overall floor plan, Fig. 9. The mounting of these components is not critical as to location and they could be mounted in existing power distribution areas if desired.

These components are the Main Plate circuit breaker, a Delta-Wye switch, a Distribution circuit breaker, a 460 to 230 volt



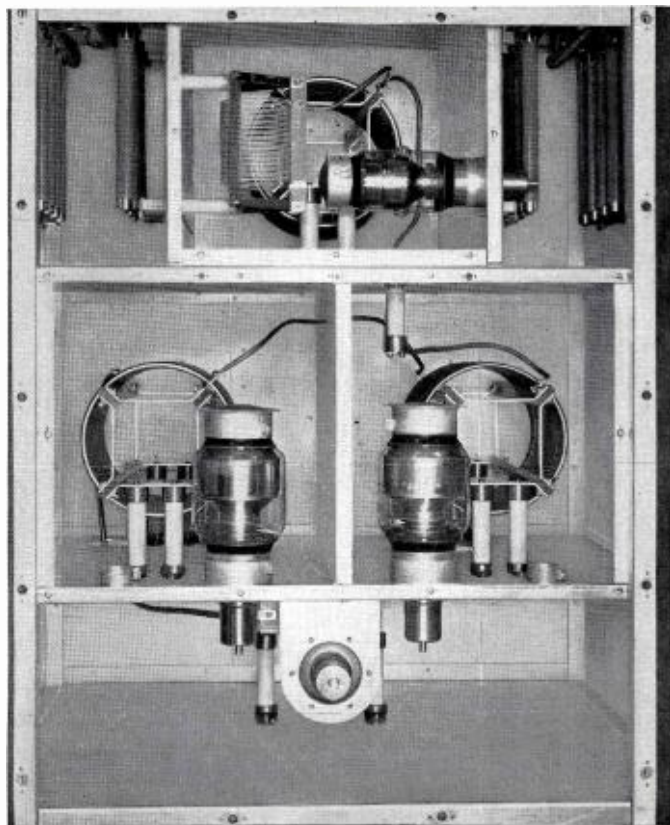

locks, mounted on 8-inch wide panels each side of the front door, are also shielded.

In the rear at the top of each cabinet is a built-in wire duct (Fig. 7) which joins similar ducts of the adjacent cabinets, so as to form a continuous duct on the four front cabinets. This duct has a divider down the center on which the interconnection terminal boards are mounted. The rear half of the duct is used for interconnection wiring while the front half is used for internal cabinet wiring from the terminal boards. The internal wiring is carried through conduits to its destination in the cabinet thus shielding all power and control wiring from R.F. fields. Provision is also made at the top of the cabinets for the addition of an exhaust air duct.

The left end cabinet and the third cabinet from the left end are identical and contain the final power amplifier stages. The 5671 tube and its grid circuits and part of the plate circuits are contained in the front portion of the cabinet. The upper rear section contains the plate tank coil,

FIG. 6. View at rear of exciter cabinet showing harmonic filter.

bank of Distribution transformers, and two single phase open Delta connected regulators with their control panels. These components are wired through conduit and overhead ductwork to the main plate transformers and the transmitter cabinets.

Each of the four in line cabinets, 44 inches wide by 60 inches deep by 84 inches high, consists of an all aluminum cubicle erected on a welded steel base. This cubicle consists of a series of panels so fabricated and assembled that they form a rigid structure with good freedom of access. The use of aluminum eliminates unnecessary weight and gives excellent shielding to assure effective confinement of spurious energy. Front access to the cabinet is through a 28-inch wide full length door while rear access is through two covers attached with quick disconnect fasteners for easy removal.

A center vertical panel separates the cabinet into a front compartment and rear compartment which is further divided by a horizontal shelf into upper and lower compartments. This gives each cabinet three basic totally shielded compartments in which to mount the electrical components. The eye-level meters, pilot lights and inter-

FIG. 7. Detail of completely-shielded interconnection wire duct (cover removed).

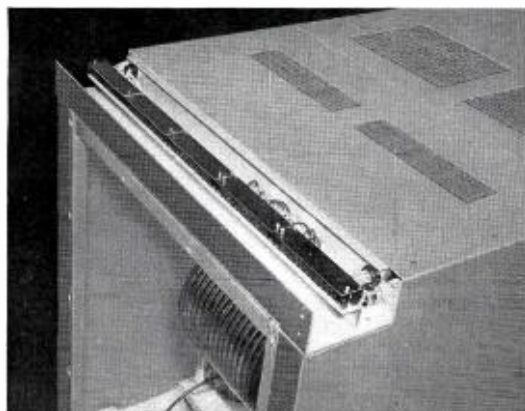
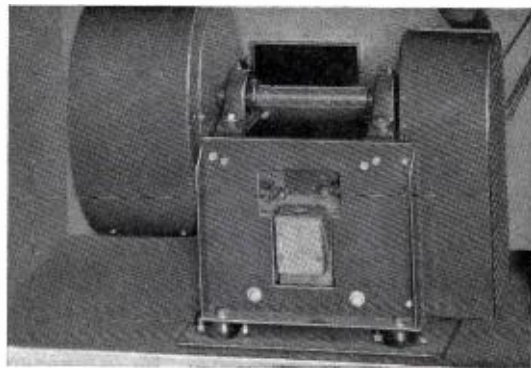

FIG. 8. Internal blower. One located in each PA cubicle.



partially visible in Fig. 7, as well as shielded filament transformer and grid leak resistors. The lower rear section contains a low noise blower (Fig. 8) which cools the 5671 tube and its cabinet and the adjacent half of the exciter cabinet. The lower rear panel contains an impingement type air filter for the blower. The PA cabinets are so constructed that the blowers and filters can be mounted externally to the cabinets, if so desired.

A cabinet located directly between the two power amplifier units (Fig. 5) houses in its front section all the components from the oscillator through the 5762 stages. The separate branches are assembled as mirror images for symmetrical feed to the PA units at left and right. The rear section contains the 50 KW common output circuit and harmonic filter (Fig. 6). Two 807 crystal oscillators are located at the bottom front of the cabinet and feed the exciter-modulator unit which is mounted on sliding rails directly above the oscillators. The exciter-modulator is a self-contained unit with the r-f and a-f components mounted on a vertical hinged panel which in turn is mounted on a horizontal chassis containing the power components for the exciter-modulator. A space is provided below this exciter-modulator for a complete duplicate unit if desired for utmost reliability. Above this space are two vertical sub-compartments behind interlocked doors which contain the 4-250 and 5762 stages. A meter panel for these stages is provided at the bottom of these sub-compartments. The common output capacitors of the 2 PA tanks and the harmonic filter are located in the upper rear of the cabinet. Sub-partitions are so arranged in this section that complete isolation and shielding is affected between the various sections of the filter and the output capacitor. The 5671 grid loading resistors are also located in separate compartments at the top of this cabinet. The lower rear section of this cabinet contains high voltage filter components.

The right hand cabinet contains the high power rectifiers, low power distribution components, and the majority of the control components. The front of the cabinet contains the 15 KV rectifier tubes and filament transformers, the 5.0/2.5 KV rectifier tubes and filament transformers, the bias rectifier, high voltage grounding switches, surge suppressor relay and resistors, the 15 KV filter capacitors, and heating and

cooling equipment to keep this section of the cabinet at the proper temperature level for best operation of the mercury vapor rectifiers. The top rear section of the cabinet contains the control relays, overload relays, distribution contactors, and low power distribution circuit breakers. The distribution breakers and overload relays are accessible without removing panels and recessed so that they will not be damaged or improperly operated. The bottom rear of the cabinet contains the 5.0 KV rectifier components including plate transformer. Operational control switches and status

lights for the entire transmitter are located on the 8-inch panels at each side of the door.

The BTA-50G transmitter incorporates all of the major advantages of low initial cost, low operational cost, inexpensive tube complement, and small size without sacrificing performance or operational ease. Excellent performance can be obtained and maintained without employing highly trained personnel. Component and tube ratings are such that the transmitter will provide adequate continuous operation for a long period at minimum cost.

### TYPICAL FLOOR PLAN

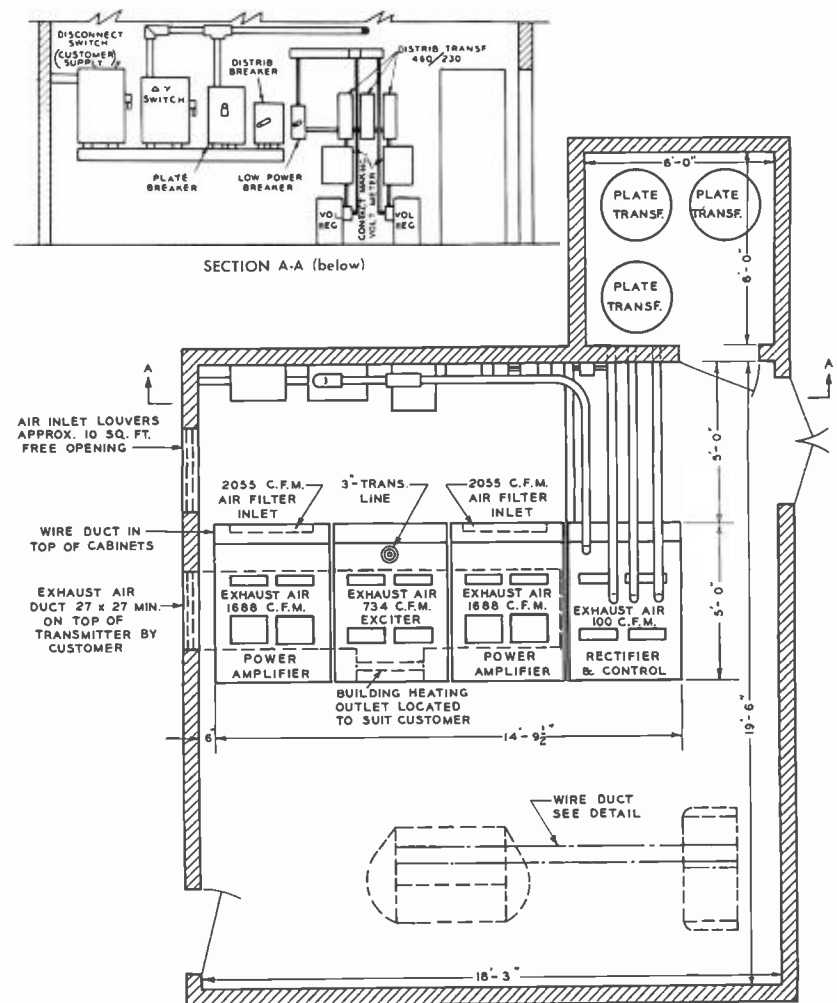

FIG. 9. Typical Floor Plan. Note: The above Floor Plan is for idea of arrangement only. Secure more accurate engineering information before proceeding with building plans.



# NEW RCA BROADCAST EQUIPMENT UNVEILED AT NARTB CONVENTION

Seven new RCA broadcast equipments were shown for the first time at the recent NARTB Convention in Washington, D. C. The equipments high-lighted the RCA display which represented one of the most complete and comprehensive exhibits of RCA broadcast equipment for VHF/UHF color and monochrome TV stations and AM/FM radio stations. Pictures on these pages show the complete equipment layout occupying an area of over 5,000 square feet.

## Live Color Camera Equipment

A completely equipped, operating color television studio was set up as a showplace for the new TK-41 Live Color Camera

equipment. This equipment features the new processing amplifier which allows economies in components, floor space and operating costs. In constant operation throughout the exhibit hours, the camera consistently produced a high resolution, low noise, live picture in full, natural colors.

## Color Effects Equipment

How to get the magic of color from black-and-white artwork was the subject of the color effects demonstration. The Color Effects equipment package enables a broadcaster to use his monochrome camera, live or film, to present commercials, titles, and station identification in color. For a description of these new techniques

see "How to Get Color Effects from Black-and-White Artwork" in this issue.

## Microwave Equipment

Completely new in design and performance, RCA Microwave, TVM-1A, carried both color and monochrome pictures during the show. Its performance was demonstrated over a simulated 20 mile path with simultaneous transmission of program sound along with picture information. This high power unit (1 watt Klystron) features transmitter automatic frequency control (AFC) and a transmitter picture monitoring output, both of which are desirable for operation of unattended repeater stations.



OVERALL VIEW OF LIVE COLOR STUDIO . . . The color studio occupied 900 square feet. Two separate sets, a puppet stage and a park scene occupied this area. Studio pictures were seen on two 21 inch RCA Color TV receivers and on two 21 inch black-and-white utility monitors. The RCA TK-41 Live Color Camera operated throughout the exhibit hours.



A PERFECT COMBINATION . . . Pretty Girls, the Park and the RCA Live Color Camera.

#### Integrated 3-V and 1-V Film Camera System

RCA's newest TP-15 Universal Multiplexer provided the nucleus of an integrated 3-V and 1-V film camera system for both color and black-and-white films. Major equipments in the system include: A 3-V Color Film Camera, TK-26A; a 1-V Monochrome Film Camera, TK-21; a 16mm Film Projector, TP-6; a 35mm Film Projector, TP-35; a 2" x 2" Slide Projector, TP-3; as well as the TP-15 Multiplexer. In this set-up any projector can operate with either camera, and both cameras can operate simultaneously. Hence color film can be run "on-air" while black-and-white is previewed, and vice-versa. Other possible combinations with this new multiplexer are described in "Some Notes on Integration of Color Equipment and Existing Monochrome Installations" in this issue.

#### Printed Circuit Audio Amplifiers

A complete line of new space-saving audio amplifiers was exhibited for the first

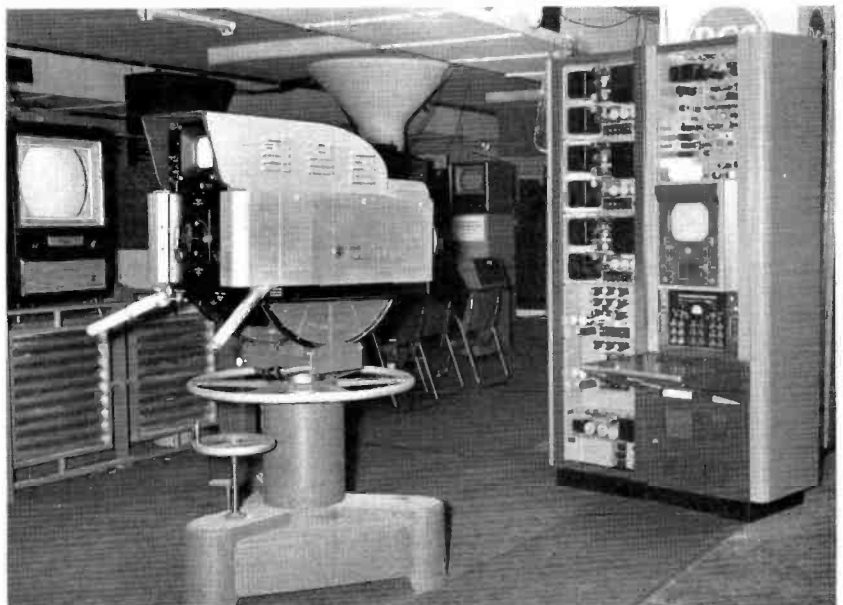

NEW TK-41 LIVE COLOR CAMERA EQUIPMENT . . . Shown here is all the equipment needed to operate a single live color camera. Housed in only two standard equipment racks are all necessary power supply, colorplexer, and control equipment. This non-operating camera was on display for customer inspection.





RCA COLOR TELEVISION PRESENTS . . . THE PERCY PUPPETS . . . A puppet variety show was presented to demonstrate the versatility of the RCA Live Color Camera.

time. These include: A BA-21A Preamplifier for microphone, turntable or booster use; a BA-23A Program Amplifier for use as a program or line amplifier, bridging amplifier, or isolation amplifier; a BA-24A Monitoring Amplifier suitable for monitoring, recording and talkback uses; as well as a BX-21A *electronically regulated* Power Supply and a BR-22A Shelf for use with these amplifiers. In addition to their space saving advantages, these latest of RCA amplifiers give better performance, greater uniformity, easier serviceability and lower power consumption than ever before.

#### 25 KW UHF Transmitter

Also introduced was the smallest, most economical transmitter developed for UHF, the RCA TTU-25B. This 25 KW transmitter, used in combination with an RCA Ultragain Pylon, allows broadcasters to achieve a million watts ERP at minimum cost. The new transmitter uses a single standard tetrode in each of the aural and visual final output stages and offers large savings in operating costs, important space-saving advantages, and simplified operation and maintenance. The improved ele-



TEST EQUIPMENT FOR VIDEO DISTRIBUTION SYSTEMS . . . The use of RCA Test Equipment, Color and Monochrome was demonstrated in this area. Special attention was devoted to the use of RCA color units in checking existing monochrome systems so they may be adapted for future color use.



TELEVISION CONTROL CENTER . . . Control and rack equipments for all operating displays in the exhibit were located in this area. Color monitors (l. to r.) showed pictures from live color camera, 3-V color film camera, and color effects equipment. New masking amplifier for 3-V equipment is shown in front of the center monitor. Remote control panel for TP-15 Multiplexer is mounted in remote control housing (center).



**COLOR FILM SYSTEM FOR CUSTOMER INSPECTION** . . . Broadcasters were encouraged to inspect and operate this TK-26 Color Film equipment for themselves. Many of them brought in their own color slides and films to run "on-camera". Note the masking amplifier located above the processing amplifier at the control position.

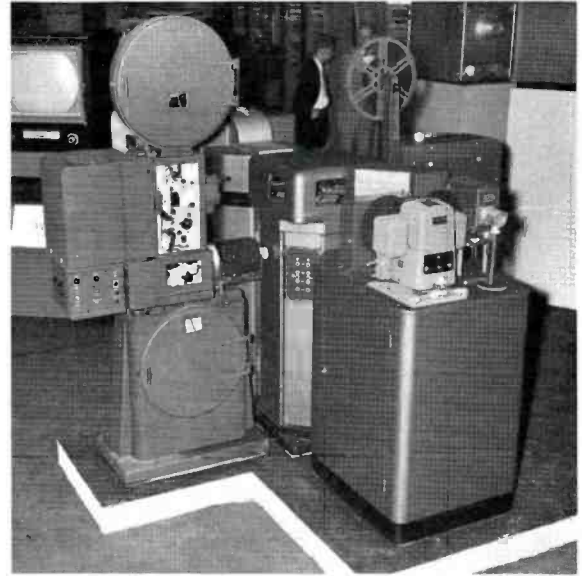

**CLOSE-UP OF INTEGRATED 1-V AND 3-V FILM SYSTEM** . . . Components of this system include: A TP-35 Film Projector (right), a TP-6 Film Projector (left), a TP-15 Universal Multiplexer Film (center), a TK-26 Film Camera (rear), and (front), a pedestal supporting a TK-21 Film Camera and a TP-3 Slide Projector.

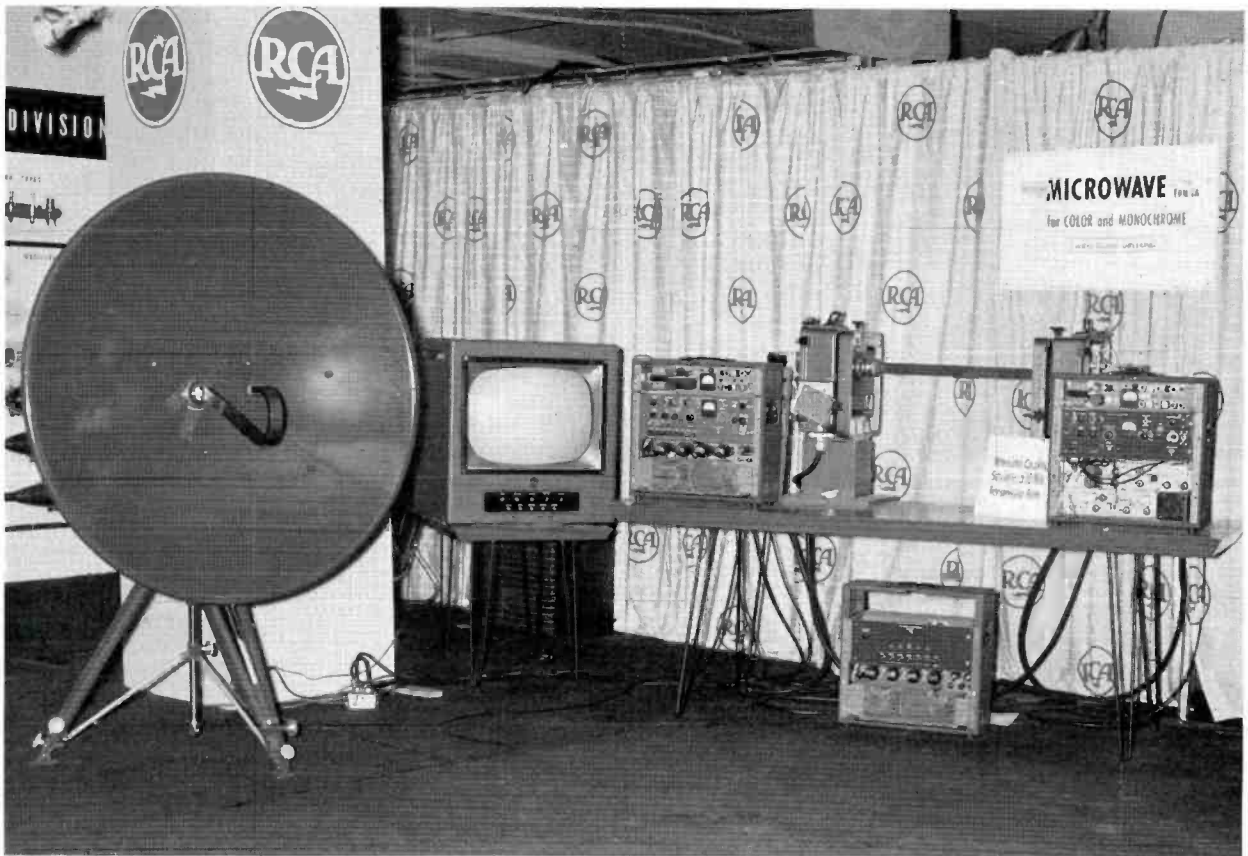

**HIGH POWER MICROWAVE FOR COLOR AND MONOCHROME** . . . This portable unit transmitted simultaneous sound and picture signals over an attenuator coupling which simulated a 20-mile transmission path. Both color and monochrome signals were transmitted. The new transmitter picture monitoring facility was demonstrated at the utility monitor (center).





**INTEGRATED 3-V AND 1-V FILM SYSTEM . . .** The new RCA TP-15 Universal Multiplexer was the hub of this film system for both color and monochrome. A 21 inch color receiver (center) displayed pictures from the 3-V camera, the utility monitor (left) showed the compatible monochrome picture from the 3-V, and utility monitor (right) showed the output of the 1-V monochrome film system.

ments which make the new transmitter possible are available to RCA 12½ KW Transmitter owners for economical conversion to 25 KW and million-watt operation.

#### 50 KW AM "Ampliphase" Transmitter

A new concept in AM transmitting equipment was introduced at the convention in the form of the RCA 50 KW "Ampliphase" transmitter. The most significant step forward in AM transmitters since RCA introduced high level modulation, Ampliphase cuts transmitter floor space and operating costs by substantial margins; does away with half of present power tubes along with bulky components such as modulation transformers, reactors and accessories. Contained in only four cubicles, it requires no underfloor trenches, costly water cooling systems, or external blower. The power amplifier cubicle of this new "fifty" was displayed.

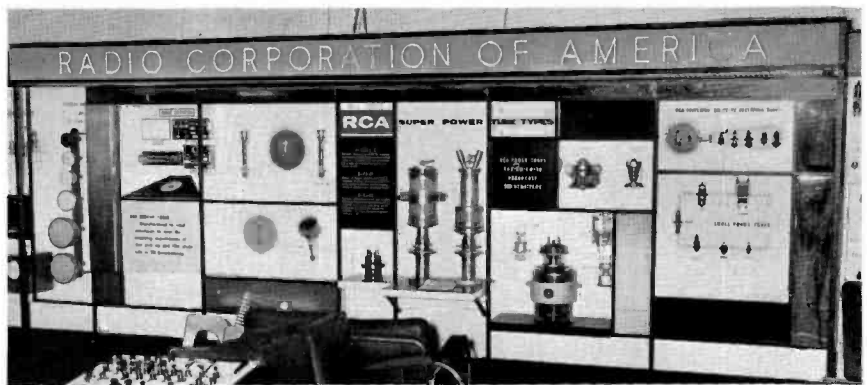

**TUBE DIVISION DISPLAY . . .** A complete line of RCA tubes for Broadcast use is shown. These include: cathode ray tubes, camera tubes, power tubes for AM/FM and TV transmitters, color TV receiving tubes, etc.



**AM IS OUR BUSINESS . . .** A complete line of RCA AM transmitters were shown in this area. From left to right: The power amplifier cubicle from RCA's new 50 KW "Ampliphase" transmitter; a complete 1 KW high fidelity AM Transmitter, BTA-1M; and RCA's newest 5 KW AM Transmitter, BTA-5H.



**RCA AUDIO EQUIPMENT FOR AM/FM AND TV STATIONS . . .** In the foreground (l. to r.) is an RCA console mounted tape recorder and two new BQ-2A Turntables flanking a BC-4A Audio Central. Cabinet racks house (left) a 250 watt AM Transmitter, and (right) a new line of printed circuit audio amplifiers.

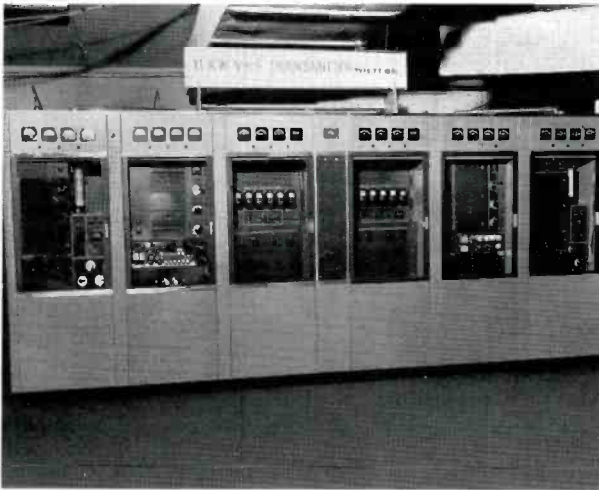

RCA's FAMILIAR TT-10AL TRANSMITTER . . . NOW RATED FOR 11 KW . . . This transmitter was shown with its new type modulator, especially designed for color. This is an RCA plus to Broadcasters who need this extra 1,000 watts to go to maximum power on channels 2 to 6. The new modulators are being supplied to present owners of RCA "10's".



NEW 25 KW UHF TRANSMITTER, TTU-25B . . . Shown for the first time, this transmitter plus an RCA Ultra-Gain Pylon Antenna will enable UHF Broadcasters to obtain 1,000,000 watts ERP. Transmitter shown occupies the same floor space as the RCA 12½ KW UHF Transmitter. Owners of RCA 12½ KW's can obtain conversion parts so they too may go to maximum power.



THE STORY OF THE RCA CANDELABRA . . . On the back wall of the color studio, the development story of the KRLD/WFAA antenna project is shown. Here miniature scale models used for engineering tests are displayed (right). Looking left is an artist's conception of the final installation and a photo mural showing the scale models being tested at the RCA Plant.



# RCA AMPLI

RCA *Ampliphase* RCA

**50-KW AM  
AIR COOLED!**

**New RCA 50-kilowatt  
AM Transmitter BTA-50G**

DESIGNED WITH  
AMPLIPHASE MODULATION

## HOW IT WORKS!

To produce phase-to-amplitude modulation in the BTA-50G, a carrier wave is developed by a common exciter. This carrier wave is then split and fed to two separate amplifier chains through phase-shift networks that establish a carrier phase difference. These two signals are controlled so that each maintains a prescribed phase relationship with the other in accordance with the intensity of modulating signal. This controlled phase relationship enables the separate 25-kilowatt amplifiers, when feeding their outputs into a combining circuit, to produce a maximum level 50-kilowatt amplitude modulated signal.

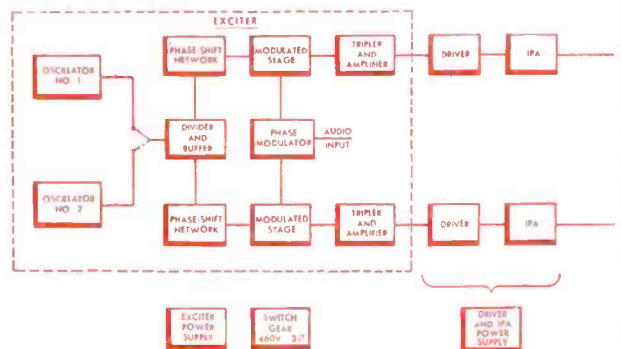

SIMPLIFIED BLOCK DIAGRAM—BTA-50G TRANSMITTER

# PHASE

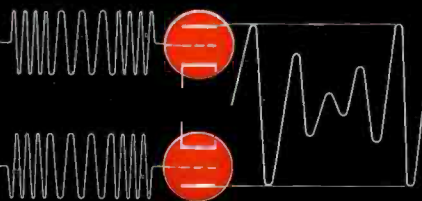

## *A new concept in AM Broadcasting!*

### *... introduced in RCA's revolutionary new 50-KW AM transmitter*

Here is the most significant forward step in AM transmitters since RCA introduced high level modulation—an entirely new 50-KW transmitter using Ampliphase Modulation. Newest and finest in RCA's long line of distinguished AM transmitter designs, it is further proof of RCA leadership in the broadcast equipment field.

Ampliphase cuts transmitter floor space and operating costs by substantial margins. The BTA-50G is housed in four cubicles. It does away with half of present power tubes . . . along with bulky components such as modulation transformers,

reactors and accessories. It requires no underfloor trenches, costly water cooling systems, external blowers. And there's no lost air-time—because the 50-KW Ampliphase is remarkably easy to install while your present transmitter is in operation. Then, in most cases, you may keep your old unit as a stand-by.

For complete technical details . . . and for information on the surprisingly low price . . . call your RCA Broadcast Sales Representative. In Canada, write RCA VICTOR Company Limited, Montreal.



#### **FACTS ABOUT RCA'S NEW 50-KW AM**

- Takes less than 80 square feet of floor space. No underfloor trenches required.
- Lowest operating cost of any 50-KW AM transmitter.
- Half the tube cost of other 50-KW AM transmitters.
- Uses famous Long-Life RCA 5671 P.A. tubes.
- No Modulation transformer required.
- Completely air-cooled with internal blowers—no air intake ducts necessary.
- Low distortion, excellent frequency response.
- Splatter-free modulation provided by new Ampliphase design.
- Designed to permit remote-control operation.
- New simplified circuitry. Extremely stable operation.

PIONEERS IN AM BROADCASTING FOR OVER 25 YEARS



**RADIO CORPORATION of AMERICA**  
ENGINEERING PRODUCTS DIVISION

CAMDEN, N.J.



# NEW RCA 25KW UHF

(TYPE TTU-25B)

## Only One Picture and One Sound P.A. Each Using A Single Tetrode

***Lowest Cost Way to Get One Million Watts!***

### **1. Lowest Operating Cost**

The TTU-25B is the smallest, most efficient high-power transmitter ever developed for UHF—color and black-and-white.

In power consumption alone, the TTU-25B is nearly twice as efficient—compared to any other high-power UHF transmitter. With new circuitry—and only one picture and one sound P.A., each using a single tetrode—a saving of nearly 50 per cent in power and tube cost is made possible.

### **2. Lowest Initial Cost**

Economy of first cost is also emphasized in this new equipment because of efficiencies of design and size. A 25% initial cost reduction over previous RCA 25KW transmitters is effected. It is the lowest cost of any comparable transmitter on the market today.

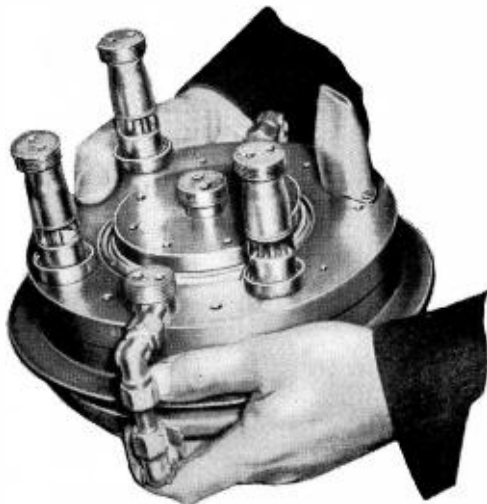

***Isn't this the answer***

The new RCA Type TTU-25B 25KW UHF operates with conventional type tubes throughout, including the new compact tetrode in aural and visual output stages. These are the types of tubes the station engineer knows and understands . . . proved in use in over a score of stations now on the air with the RCA 12½ KW.



**FOR COLOR OR MONOCHROME**

The TTU-25B, like all RCA TV Transmitters now in production, is designed to meet fully FCC Color Standards.

# Super Powered

### 3. Half the Floor Space

Because of the TTU-25B's compact size—same size as the RCA 12.5KW transmitter—only half the floor space of the previous RCA 25KW transmitter is required. Benefits to you: Savings in building costs, and corresponding savings all along the line.

**to your need for a super-powered transmitter ?**

*For complete information, call your RCA Broadcast Sales Representative. Ask for full illustrated 12-page brochure describing the new TTU-25B. Also ask about "conversion package" for present RCA TTU-12A transmitter users. In Canada, write RCA VICTOR Company Limited, Montreal.*



**RADIO CORPORATION of AMERICA**  
ENGINEERING PRODUCTS DIVISION  
CAMDEN, N. J.

RCA PIONEERED AND DEVELOPED COMPATIBLE COLOR TELEVISION





**NEW BQ-2A 3-SPEED TURNTABLE** designed specifically for 33½, 45 and 78 RPM operation. Low in price, but retaining highest performance characteristics. Simple, sure-fire drive mechanism with self-compensating rim drive. Smooth half-turn starting at any speed for easy cueing.



**BQ-70F DELUXE, 3-SPEED TURNTABLE.** Newest edition of RCA's famous 70-series transcription turntables. Photo shows installation of Universal Tone Arm for Vertical and Lateral standard groove transcriptions and a light-weight tone arm for 45 and 33½ fine-groove recordings.



**BC-4A AUDIO CONTROL.** This new unit provides adequate control and switching for one studio, 2 remotes, and tape recorder. Addition of a second BC-4A doubles facilities, permits dual-channel operation. Ideal audio sub-control for TV stations.

# Everything in Audio

Pictured on these pages are just a few of the units—from the most complete line of professional audio equipment for AM, FM and Television.

Application-engineered to fit every Broadcast audio pick-up and reproduction situation in the station, this comprehensive line includes...microphones and microphone accessories...turntables...tape recorders...amplifiers...loudspeakers...custom-built equipment...plus hundreds of other audio items needed to meet each

and every station requirement.

RCA audio equipment is imaginatively designed to exceed present-day station requirements—*competitively*. It makes possible new techniques in program handling—offers a new basic approach to greater operation economy. Ask your RCA Broadcast Sales Representative for complete technical information. In Canada, write RCA Victor, Ltd., Montreal.



**BC-2B STUDIO CONSOLETTA.** "Low-boy" console offers deluxe, operation-proved features usually found in custom-built equipment—but at a standard "package" price. Includes complete high-fidelity speech input provisions for 2 studios, announce booth, 2 turntables, 5 remotes, and network.

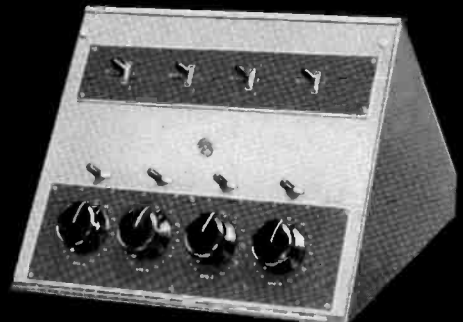

**BCM-1A AUXILIARY MIXER CONSOLE.** For large AM and TV studios. It triples the microphone inputs of the BC-2B—up to 16 microphones can be connected—8 can be used simultaneously. Enables you to "block-build" as required.



**RT-12B PROFESSIONAL TAPE RECORDER (CONSOLE TYPE).** Same as RT-11B and includes all the design features of the rack-mounted unit—but is ideal for use near the RCA Consolelette or turntables in control rooms or studios where rack space is not available.

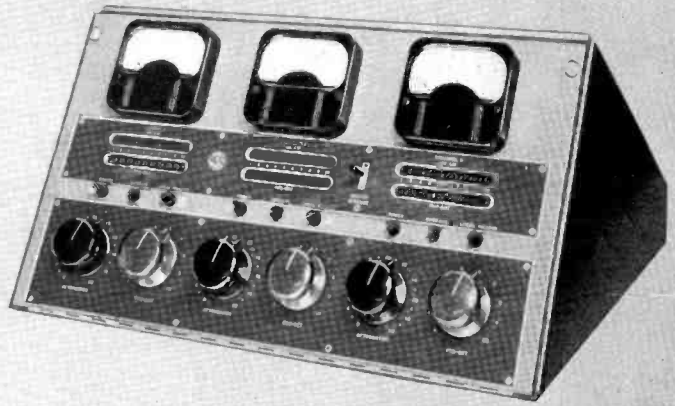

**BCS-11A MASTER SWITCHING CONSOLELETTE.** For broadcast stations requiring master switching facilities for three channels. Can be used for pre-set master switching—up to 10 program sources.

# ...for AM or TV!

FREE technical brochures on RCA Broadcast Audio Equipments—from your RCA Broadcast Sales Representative. Ask for the bulletins you desire by the numbers given below:

| ITEM  | NUMBER  |
|---|---------|
| BC-4A Audio Control.....                                    | B. 1112 |
| BC-2B Studio Consolelette.....                              | B. 1100 |
| BCM-1A Auxiliary Mixer Console.....                         | B. 1108 |
| BCS-11A Master Switching Consolelette.....                  | B. 1116 |
| BQ-1A Turntable.....  | B. 1616 |
| BQ-70F Deluxe, 3-speed Turntable.....                       | B. 1600 |
| RT-11B Professional Tape Recorder<br>for Rack Mounting..... | B. 1700 |
| RT-12B Professional Tape Recorder<br>(Console Type).....    | B. 1700 |
| BTC-1B Transmitter Control Console.....                     | 2J 8256 |

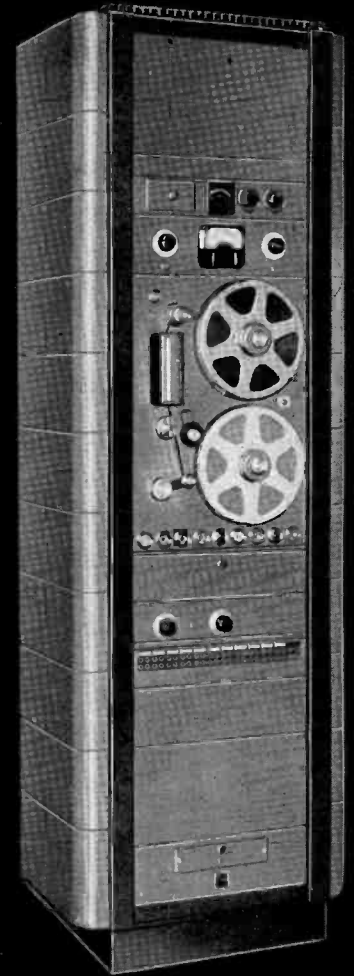

PIONEER IN AM BROADCASTING FOR OVER 25 YEARS



**RADIO CORPORATION of AMERICA**  
ENGINEERING PRODUCTS DIVISION

CAMDEN, N. J.



**BTC-1B TRANSMITTER CONTROL CONSOLE.** Handles all audio mixing and transmitter switching for AM station operation. Add-a-unit design does away with obsolescence—enables you to add control turrets and desk sections as your station grows.

**RT-11B PROFESSIONAL TAPE RECORDER FOR RACK MOUNTING.** Designed for applications where precision timing and reliability are prime factors. RT-11B provides push-button control, automatic tape lifters, quick starts and stops in 1/10 second, and easy cueing.





# NEW RCA SSB-1 TRANSCEIVER OPENS A NEW ERA IN LOW-COST HF COMMUNICATION

**COMPACT NEW RCA SSB-1** is only 24½" high, 22¾" wide, 16¾" deep. Ideal for simplex and duplex radio-telephone and radiotelegraph services.



**FOR THE FIRST TIME** in HF Telecommunications, RCA is making available the proved advantages of single-sideband communications . . . at a cost everyone can afford. This technique of communications has been used in intercontinental telephony since 1926, but never before has it been offered at such a low price.

Another advantage that will be welcomed by users of high frequency telephony and telegraphy is the extremely simple operation of RCA's new SSB-1. And of course, the SSB-1 offers you the practicality and dependability that have made RCA communications equipment world-famous. For full details, see your RCA distributor or write for free booklet today!

### THE 60-WATT SSB-1 GIVES YOU THESE 6 BIG FEATURES:

1. **SPECTRUM CONSERVATION**—Uses less than ½ frequency bandwidth of conventional AM.
2. **HIGHER EFFECTIVENESS**—60-Watt SSB-1 is equal to 500-Watt conventional AM Transmitter.
3. **REDUCTION OF DISTORTION AND INTERFERENCE**—50% less interference than conventional AM.
4. **VERSATILITY**—Four channels, telegraphy and telephony.
5. **SIMPLICITY**—Does not require a technical operator.
6. **ECONOMY**—Low initial and operating costs.

**FREE**

Send for booklet giving full details of the new RCA SSB-1. Write:



TRADEMARK(S) © REGISTERED  
MARCA(S) REGISTRADA(S)



RCA INTERNATIONAL DIVISION  
**RADIO CORPORATION of AMERICA**  
30 ROCKEFELLER PLAZA, NEW YORK, N. Y., U. S. A.

Right From WAVE-TV's Station Log...

# 7,288 HOURS ON AIR

*...and still going strong!\**

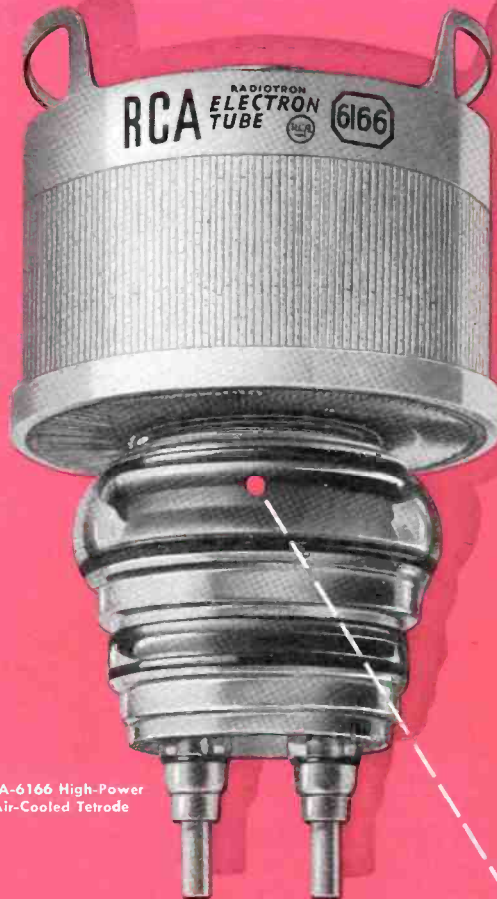

RCA-6166 High-Power  
Air-Cooled Tetrode

*\*says W. E. Hudson, Chief Engineer at WAVE-TV*

"One of our RCA-6166 power tetrodes has already been operating for 7,288 hours," (as of December 21, 1954) states Mr. W. E. Hudson, Chief Engineer of WAVE-TV. "And it shows no inclination of asking for retirement!" This tube, originally used in WAVE-TV's 10-kw visual output stage, is now driving the station's high-power aural output stage.

Type 6166 is just one of the many RCA power tubes now delivering long and faithful service in television stations throughout the country. And there are basic reasons to support such records. For example, RCA power tubes are conservatively rated. They have great reserve of filament emission. And they are backed by more than a quarter century of "proved-in" life performance in broadcast and television stations of every power.

Broadcasters have come to depend on the reliable operation of RCA Power Tubes . . . operation that pays off: in lower capital investment per hour of tube performance—lower operating cost—minimum "down time."

Your RCA Tube Distributor handles a complete line of RCA power tubes for broadcast and TV operations. For prompt service, call him.

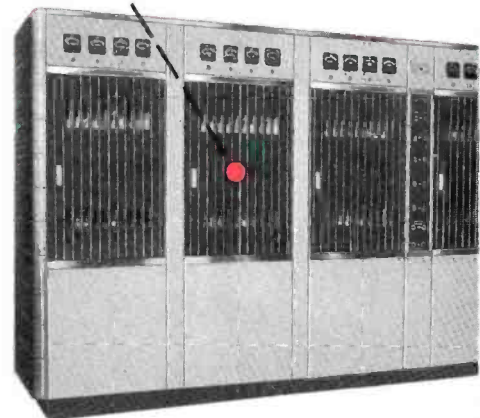

**RADIO CORPORATION of AMERICA**  
ELECTRON TUBES  
HARRISON, N.J.





## RCA's BRILLIANT "21"

One day color television will reach virtually every farmhouse, city and suburban home in America. Compatible color television, pioneered and developed by RCA, is on the march with RCA's big new 21-inch color tube—whose 255 square inches of viewing area open a new world of color for all America.

Dependable in performance, spectacular in quality, this new tube in conjunction with the RCA magnetic equalizer blends the colors evenly to the extreme edges of the picture.

The scientific and engineering advances in this tube

are typical of every product under the trademark "RCA"—world-wide symbol of quality, dependability, and progress.

In the David Sarnoff Research Center at Princeton, New Jersey, in the RCA Victor manufacturing plants, in the NBC broadcasting stations, as well as in RCA's world-wide radiotelegraph stations, there are 70,000 members of the RCA Family. As one of America's foremost industrial teams they work to advance radio, television and electronics for civilian and industrial uses as well as for national defense.



RADIO CORPORATION OF AMERICA

**ELECTRONICS FOR LIVING**